

IMPROVISED SHAPED CHARGES



**DESERT
PUBLICATIONS**

CORNVILLE, ARIZONA 86325

Look to the leader, Desert Publications, for the finest in improvised munitions, firearms, survival, self-defense, military & police science, alternate energy and underdog justice books.

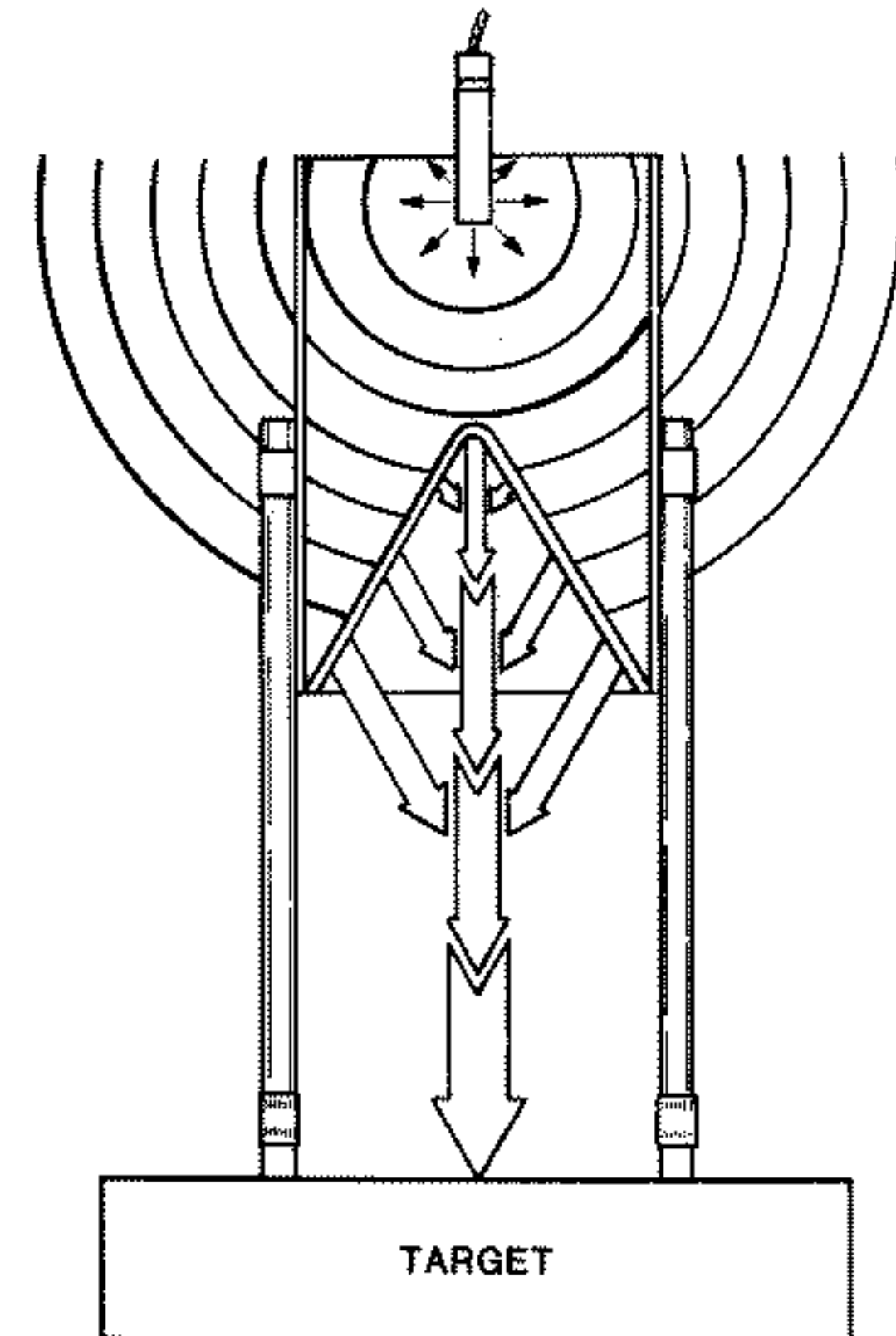

DESERT PUBLICATIONS

IMPROVISED SHAPED CHARGES

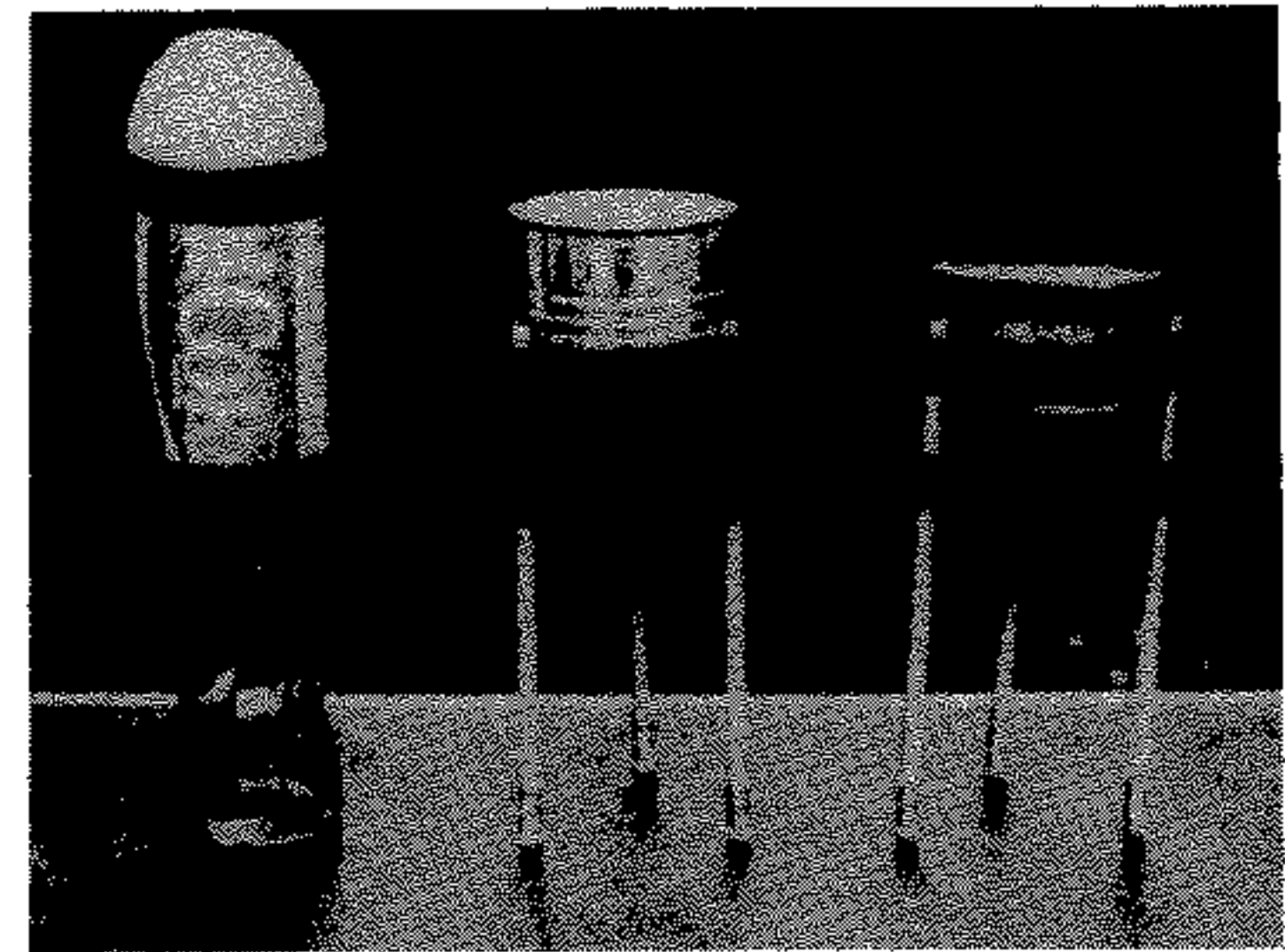

 **DESERT PUBLICATIONS**

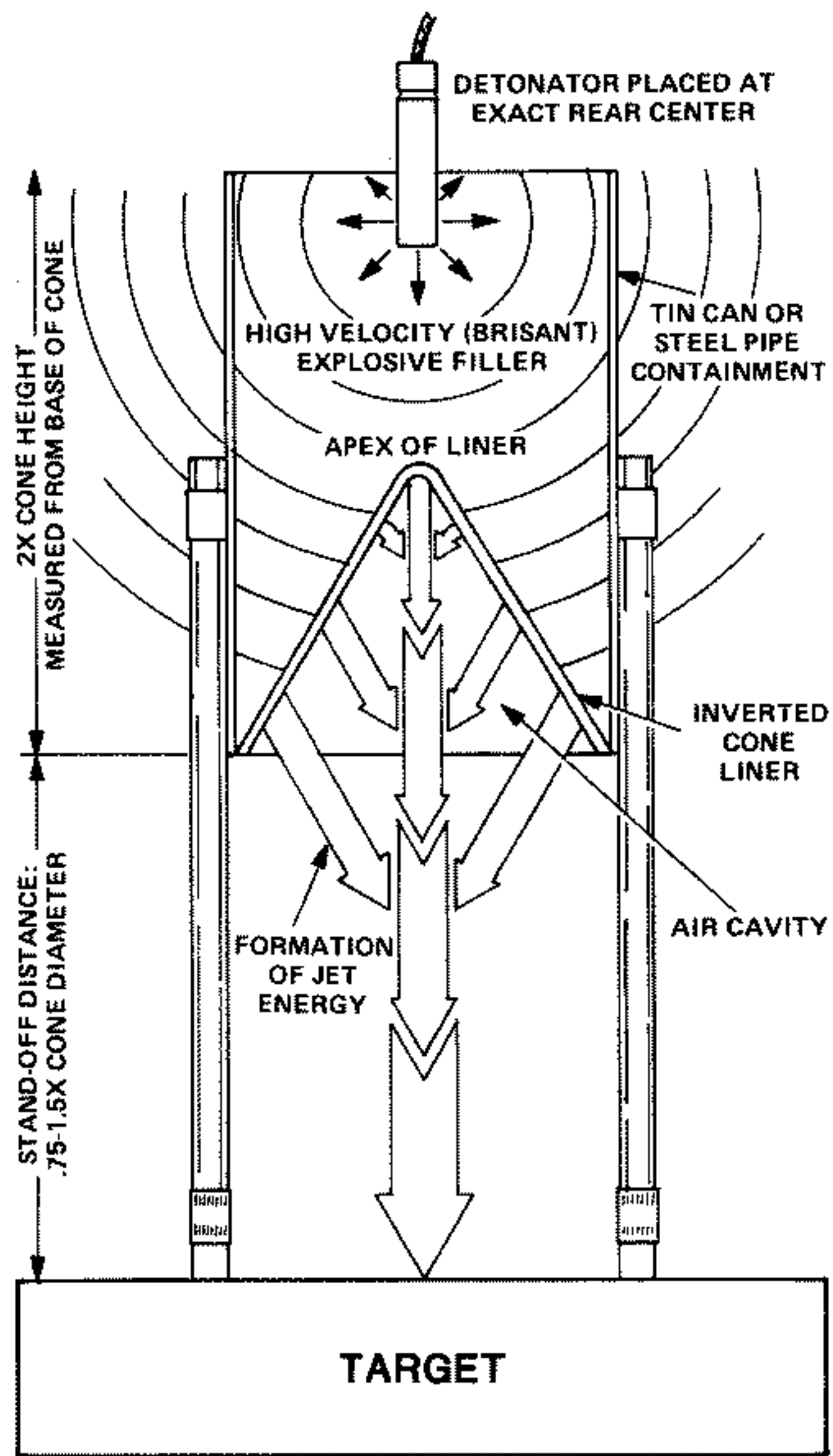
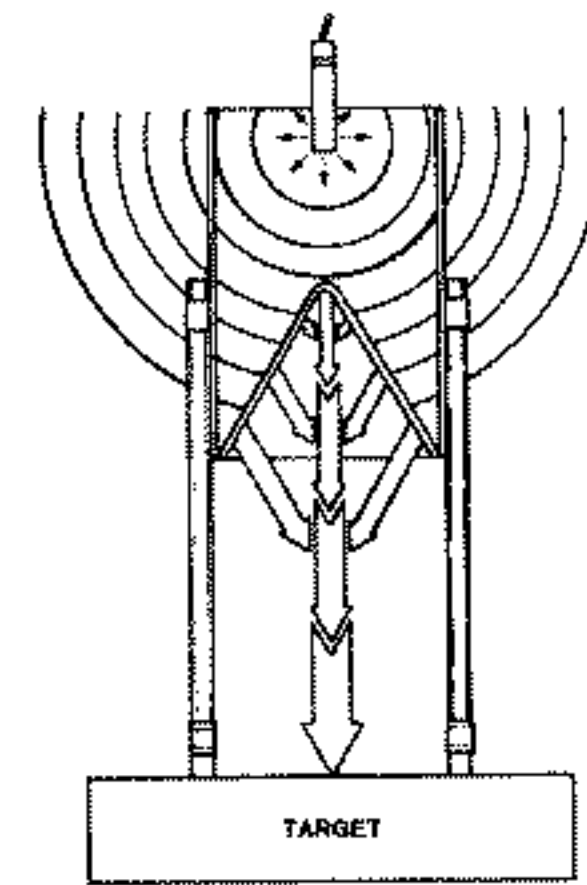

FIGURE 1
Shaped Charge



I. General Information

A shaped charge (Figure 1) is an explosive mass which is so shaped that when detonation of the charge occurs the explosive energy is concentrated in one direction. This feature gives the shaped charge greater penetrating effect than ordinary charges and thus makes it most useful for the blasting of holes through hard targets such as automobile engines, steel-encased transformers, etc.

Any flat-sided charge which is detonated while in contact with steel produces a basin-shaped indentation (Figure 2).

If a simple cavity is fashioned in the target end of the same charge, it will cause an increase in penetration regardless of the geometric shape of the cavity (Figure 3).

When the cavity is lined with a material which has a low melting point (e.g. copper or glass), penetration is increased further (Figure 4).

Maximum penetration results when the shaped charge with cavity liner is detonated a short distance from the target. This distance is called standoff distance (Figure 5).

IMPROVISED SHAPED CHARGES

© 1982

Desert Publications

ISBN: 0 - 87947 - 250 -2

DESERT PUBLICATIONS
Cornville, Arizona 86325

Table Of Contents

I. General Information	1
II. Theory Of Shaped Charges	5
III. Characteristics Of Shaped Charges	9
IV. Improvising Shaped Charges	13

IMPROVISED SHAPED CHARGES

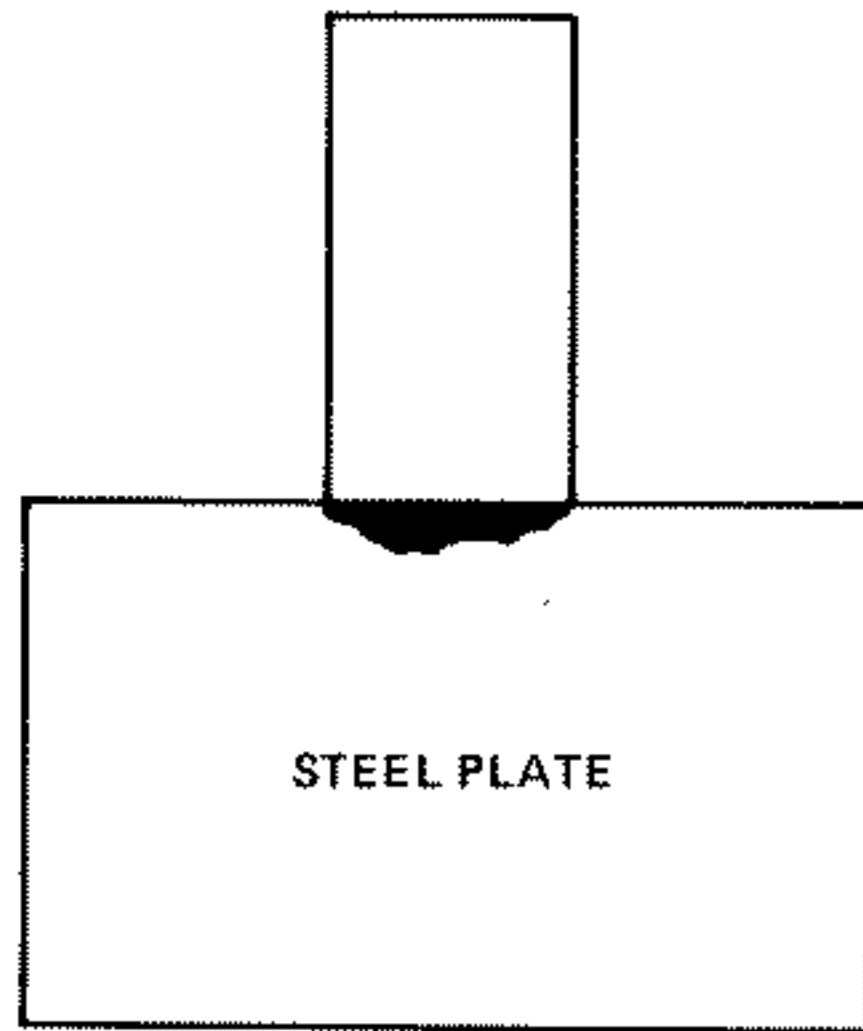

FIGURE 2
Plane Ended Charge

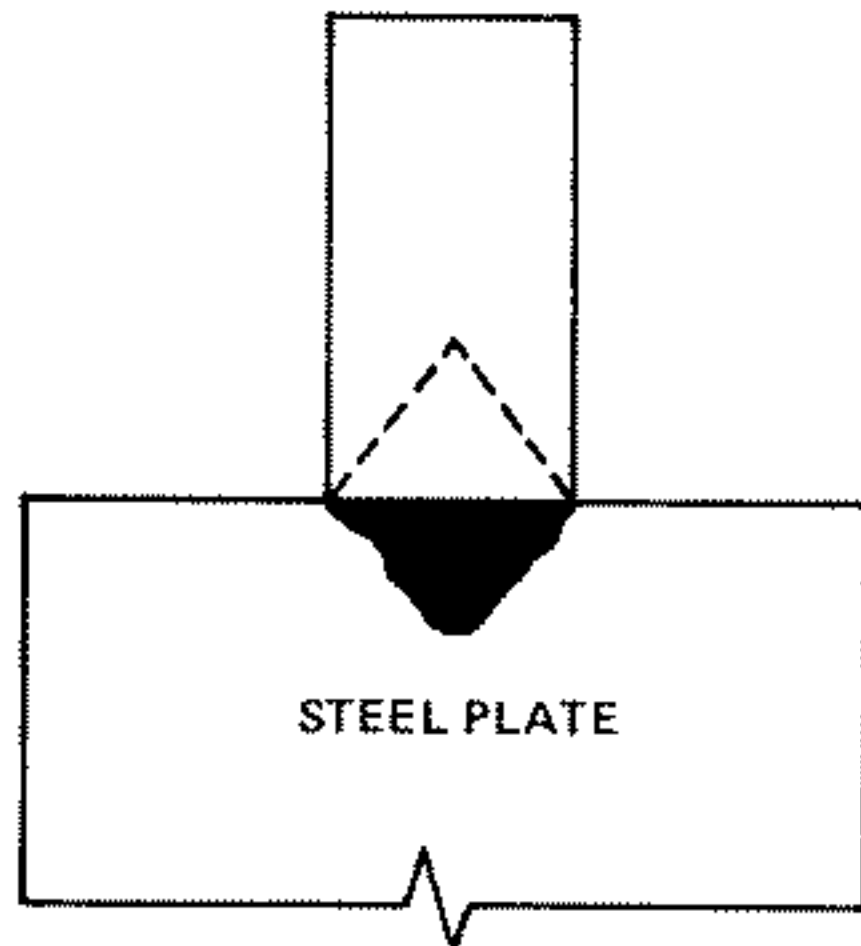

FIGURE 3
Shaped Charge Without Liner

IMPROVISED SHAPED CHARGES

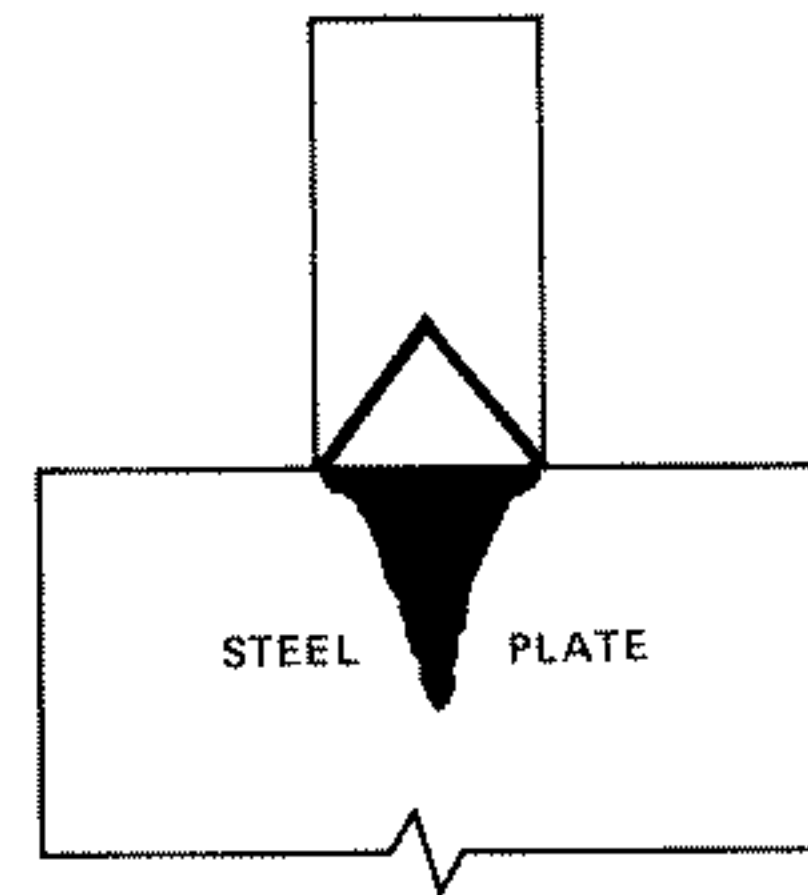

FIGURE 4
Shaped Charge With Liner

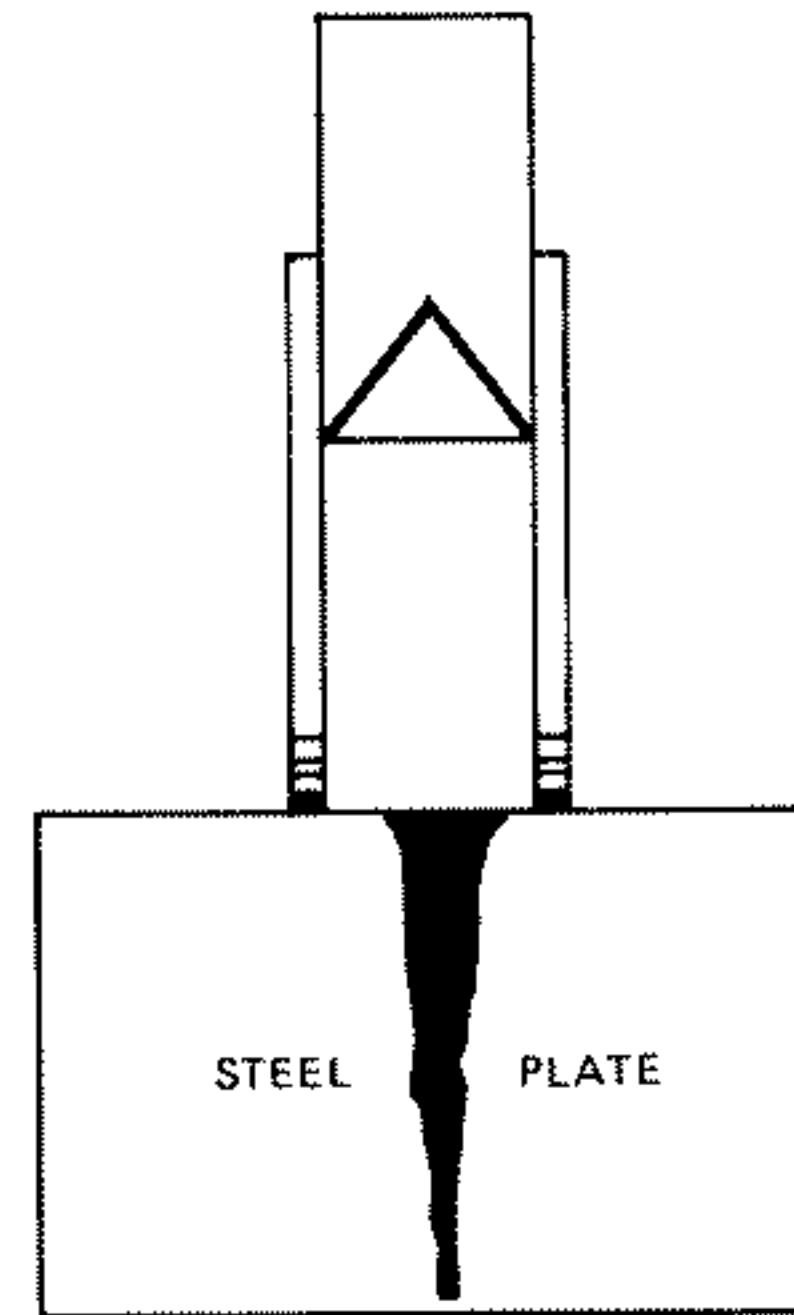
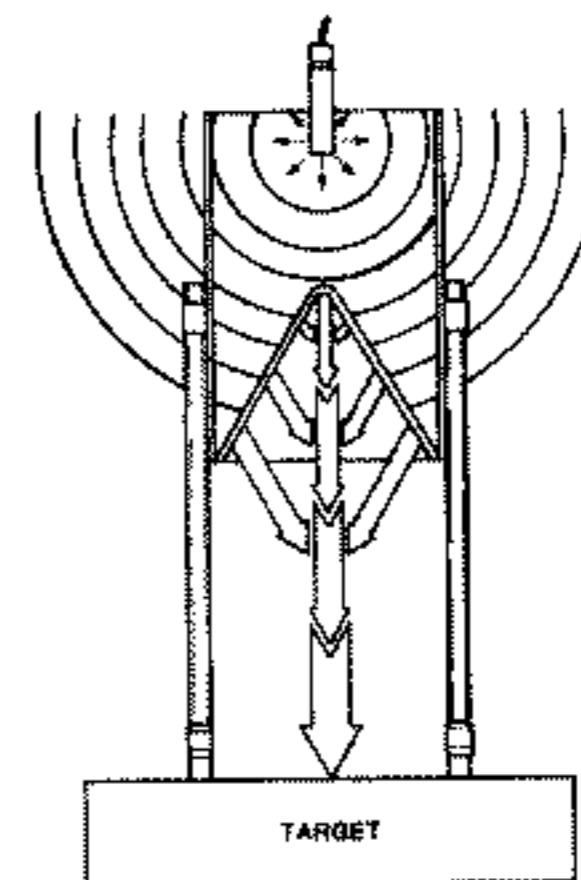

FIGURE 5
Shaped Charge With Liner And Standoff

IMPROVISED SHAPED CHARGES

Each of the charges shown in Figures 1-5 consists of the same weight and type of explosive. Since one of the most important concepts to bear in mind when using improvised explosives is to always try to "limit the amount and maximize the potential", shaped charges are excellent examples and should be used on targets such as electric motors, generators, transformers, steam turbines and various types of pumps as well as other targets that may be irreparably damaged by small shaped charges.



II. Theory Of Shaped Charges

The existence of a shaped cavity in one end of an explosive charge causes a directional development of explosive energy which occurs simultaneously with detonation. This directional force results from the high velocity of the gaseous and semigaseous molecules within the cavity. The force leaving the surface of any detonated explosive falls off rapidly at even a short distance from the explosive. This is not the case within the cavity of a shaped charge, where there is an actual increase in velocity of the expanding gas.

A logical assumption as to why this occurs is that the shock wave transmitted to the shaped charge explosive by a blasting cap causes a detonating wave to proceed downward and outward through the explosive at uniform speed. The descending detonating wave-fronts first come in contact with the cavity liner apex. The temperature at the cavity liner during detonation is normally from 1,800 to 3,600 degrees F.; the velocity of the explosive normally ranges between 20,000 to 28,000 feet per second. Confronted by the extremely hot

IMPROVED SHAPED CHARGES

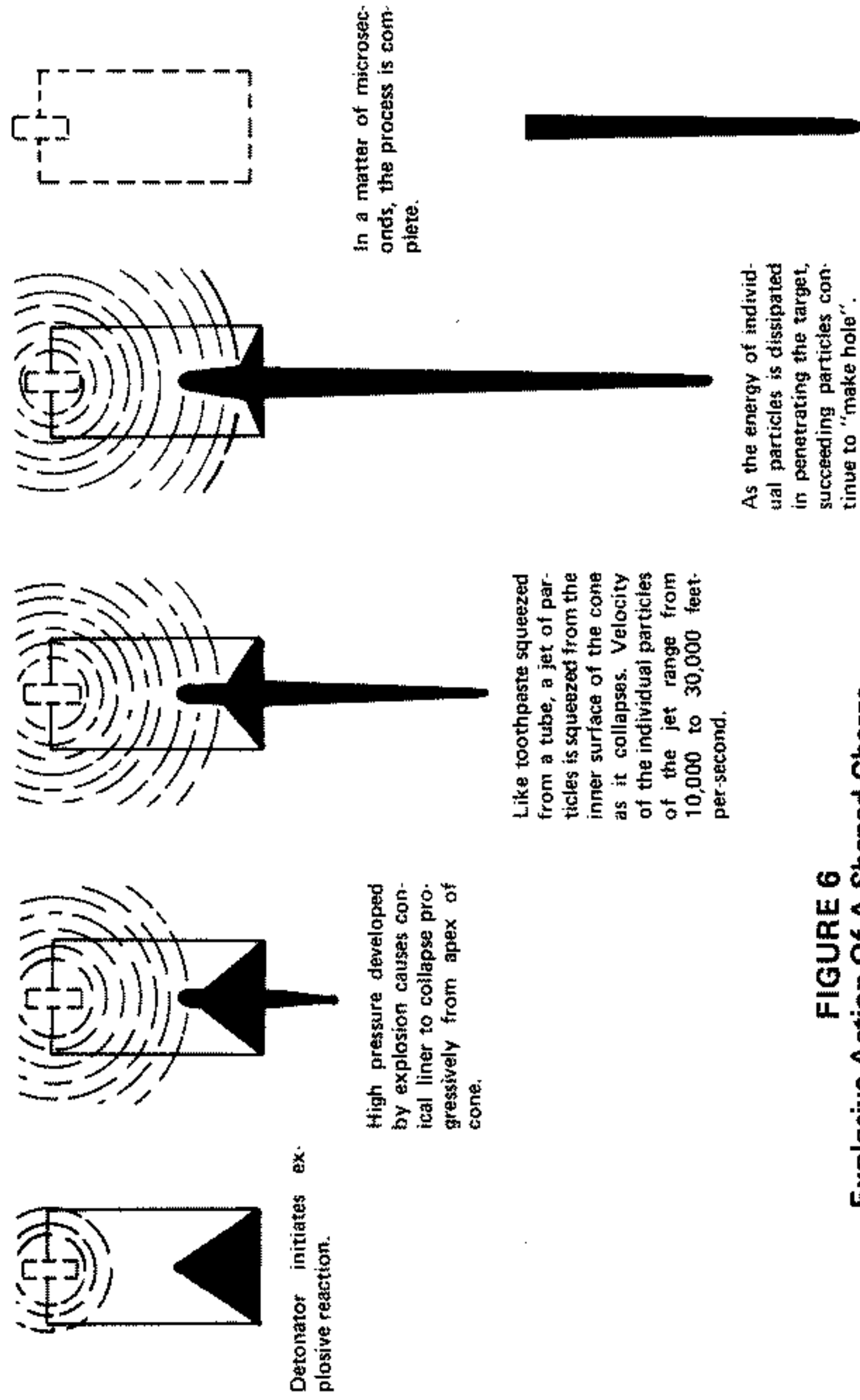
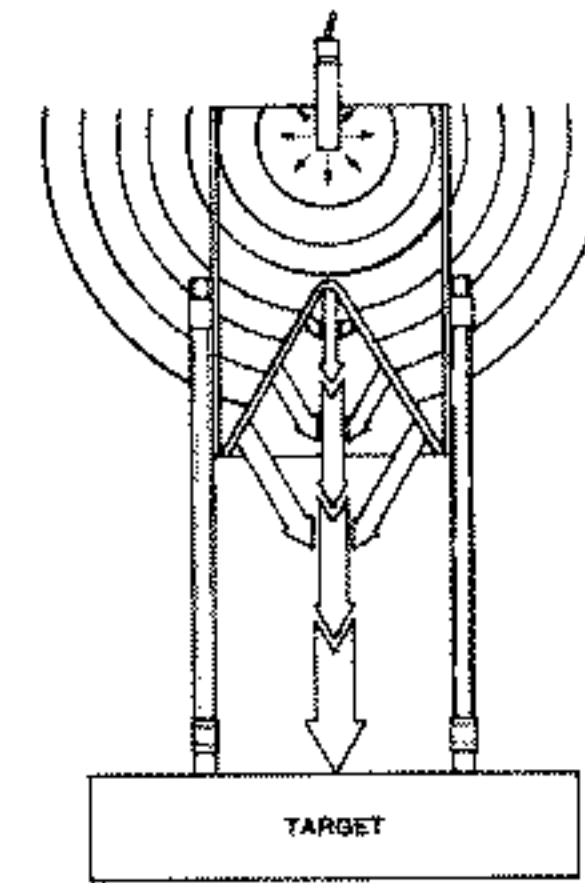
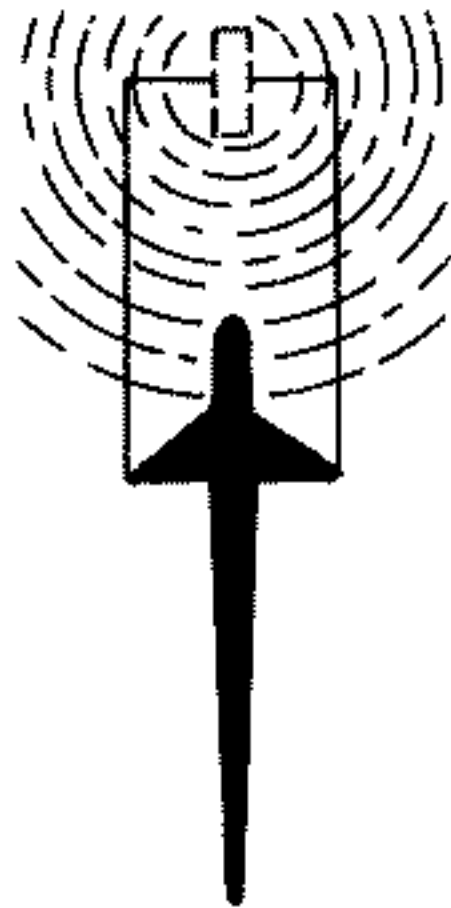

FIGURE 6
Explosive Action Of A Shaped Charge

IMPROVED SHAPED CHARGES

and rapid detonating wave-fronts, the portions of the liner nearest the apex squirt forward as minute fragments, molten matter and even vapors. Coincident with this action the ever-descending detonating wave-fronts reach lower and lower planes of the cavity liner (Figure 6). This tends to cause compression toward the center of the cavity, thereby adding to the impetus of the jet. The front of this jet is composed of highly dense gas and solid particles moving at speeds in excess of the detonating explosive. This is followed by slower-moving fragments, the residue of the highly compressed liner and fragments torn from the skirt of the liner.

Penetration is achieved when the high velocity jet gases and particles strike the target. Stated technically, the concentrated force of the jet makes an indentation in the target which is enlarged by radial pressure. This causes detrusion or plastic deformation of the target. Unless the jet penetrates the target there is no loss of target weight and the material is merely pushed out of the jet's path. On the other hand, if the jet is capable of penetrating the target, the pressure will at some point be sufficient to force out a plug of target material. The jet, after it has pierced a target, may still exhibit considerable residual energy and cause further damage to the target.



III. Characteristics Of Shaped Charges

The design of a shaped charge is complicated by the interdependence of several factors which are discussed below. In many cases, particularly in homemade shaped charges, jet efficiency must be compromised by considerations involving one or more of these factors, with a resultant reduction in performance.

The interdependent factors which must be kept in mind are:

1. **Uniformity:** The uniformity of a shaped charge about a central axis is of great importance and of equal importance is the uniformity of the explosive which has an effect upon the uniformity of detonation. If a solid explosive is used it should be packed evenly (uniformly) around the inverted cone without lumps or air pockets and the explosive should be

IMPROVISED SHAPED CHARGES

detonated at the exact rear center, directly opposite the apex of the cone. Thickness of the explosive between the apex of the cone should be equal to at least the height of the cone. Homemade liquid explosives, because of their uniform density, make excellent explosives to be used in any improvised shaped charges.

2. **Liner Considerations:** Shaped charge liners have been fabricated in many shapes and of a great variety of materials. For deep penetration, copper linings give maximum performance. Cadmium, zinc, mild steel, aluminum and glass also assure satisfactory results. Most cavity liners are of a conical shape and have apex angles of 30 to 60 degrees. The thickness of the cavity liner should be uniform and should be proportional in shape from the apex to the mouth of the cone.
3. **High Explosive Fillers:** Generally speaking, the more brisant explosives are the best for shaped charges. Explosives with velocities of detonation greater than 6,000 meters per second (MPS) should be used. However, improvised explosives with velocities as low as 3,000 MPS can be used. For the purpose of this text C-4 plastic explosive (8,000+ MPS) was used to show maximum results with homemade liners. However, explosives such as potassium chlorate/nitrobenzine (82%/18% at 3,500 MPS) can be used with approximately 50% reduction in penetrating ability.
4. **Containment:** Containment applies to the outer container which houses the explosive around the cone. When using high velocity explosives (6,000+ MPS) strong confinement does not enhance the over-all penetrating effect to any great degree and thin-walled containment can be used. However, when

IMPROVISED SHAPED CHARGES

using improvised explosives with low detonating velocities (3,000 to 6,000 MPS) confinement becomes critical to their performance and strong-walled containers such as steel pipes should be used.

5. **Standoff distance:** Standoff is the term used to define the airspace between the base of the shaped charge liner and the target. This space is necessary to allow formation of the jet and any hindering material in this space will markedly reduce penetration. In shaped charges with conical liners, standoff for optimum performance increases in direct proportion to increases in the apex angle. For homemade shaped charges the standoff distance can be anywhere from 0.75 to 1.5 times the cone diameter. For the purpose of this text we used the greater distance of 1.5 times the cone diameter with extremely effective results.

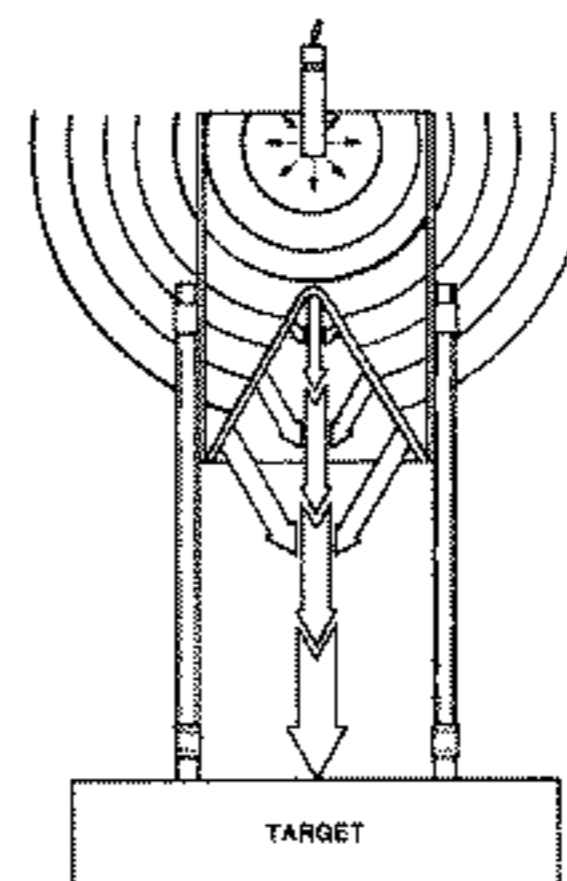
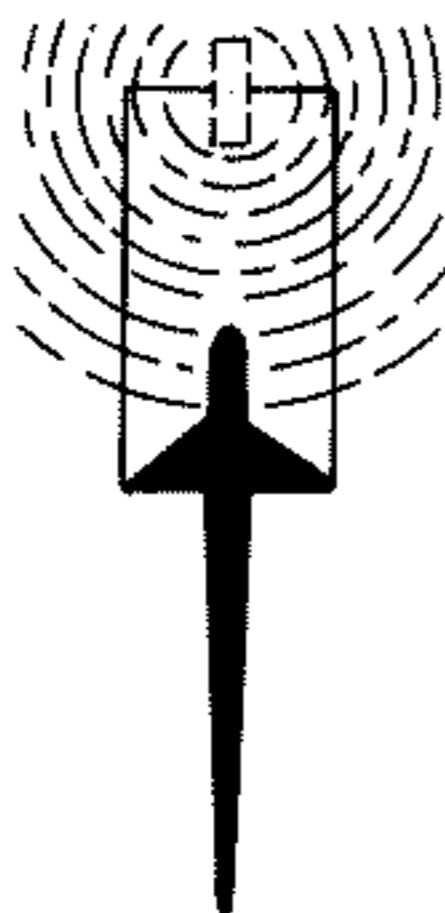

IV. Improvising Shaped Charges

Any symmetrical glass utensil will serve as a suitable cavity liner for improvised shaped charges. Generally speaking, the more conical the shape the better the resulting penetration. Therefore, an inverted martini glass (with stem removed) would be better than an inverted water glass.

In the photos accompanying this text we used three ordinary, commonly available glass cones (Figure 7) to form the liners for three improvised shaped charges (Figure 8) used against two inch thick armor plate (which happened to be the door off an explosive storage bunker).

COKE BOTTLE IMPROVISED SHAPED CHARGE

A 16 ounce Coke bottle was used for test purposes, but a 6½ ounce bottle will work just as well, giving the same penetrating ability with the expenditure of a lesser amount of explosive.

IMPROVISED SHAPED CHARGES



FIGURE 7

From left to right: Wine bottle, Coke bottle and martini glass were used to form liners for improvised shaped charges.

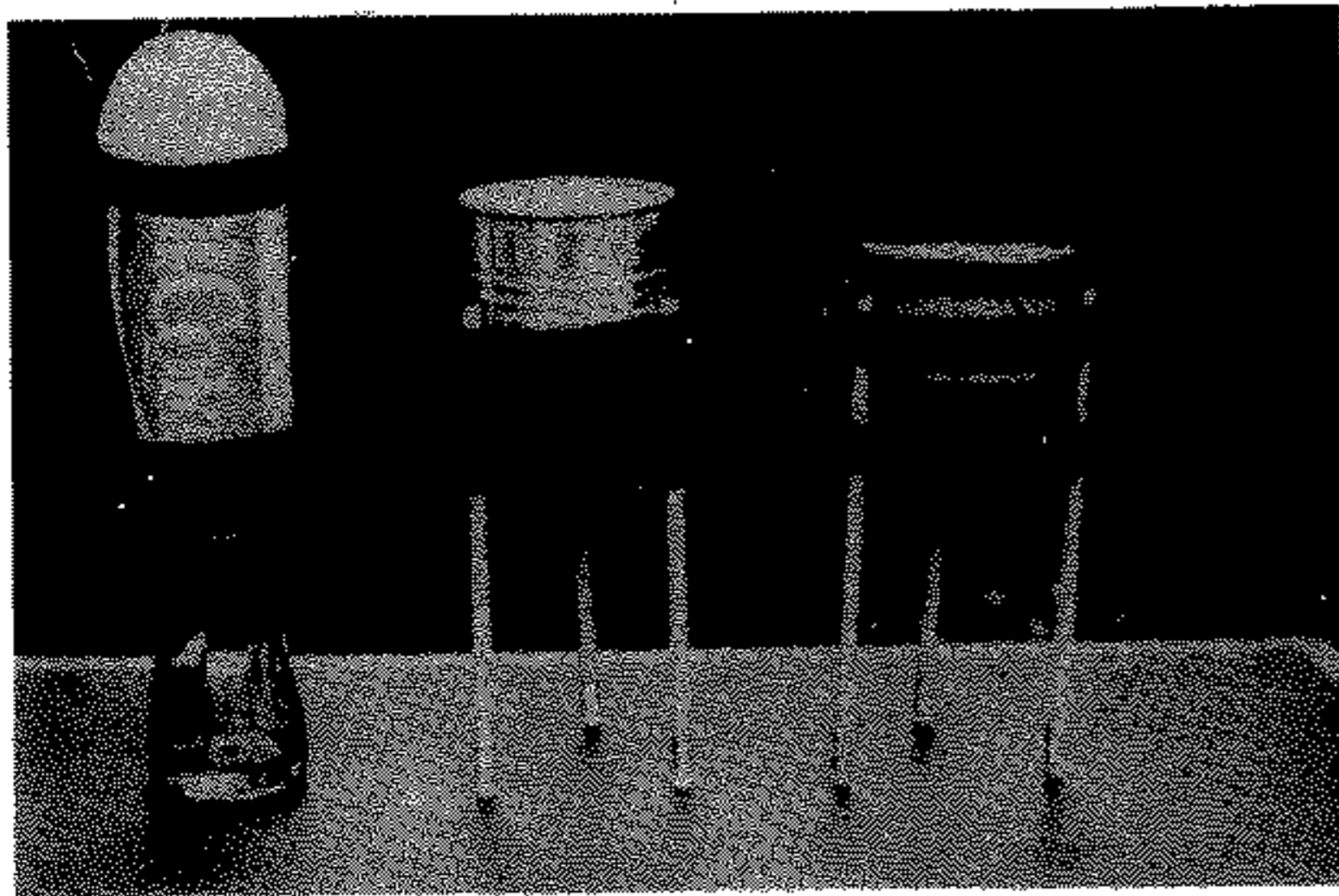

FIGURE 8

The finished shaped charges are shown above. Note pencil tripods used to create standoff on center and right charges.

IMPROVISED SHAPED CHARGES

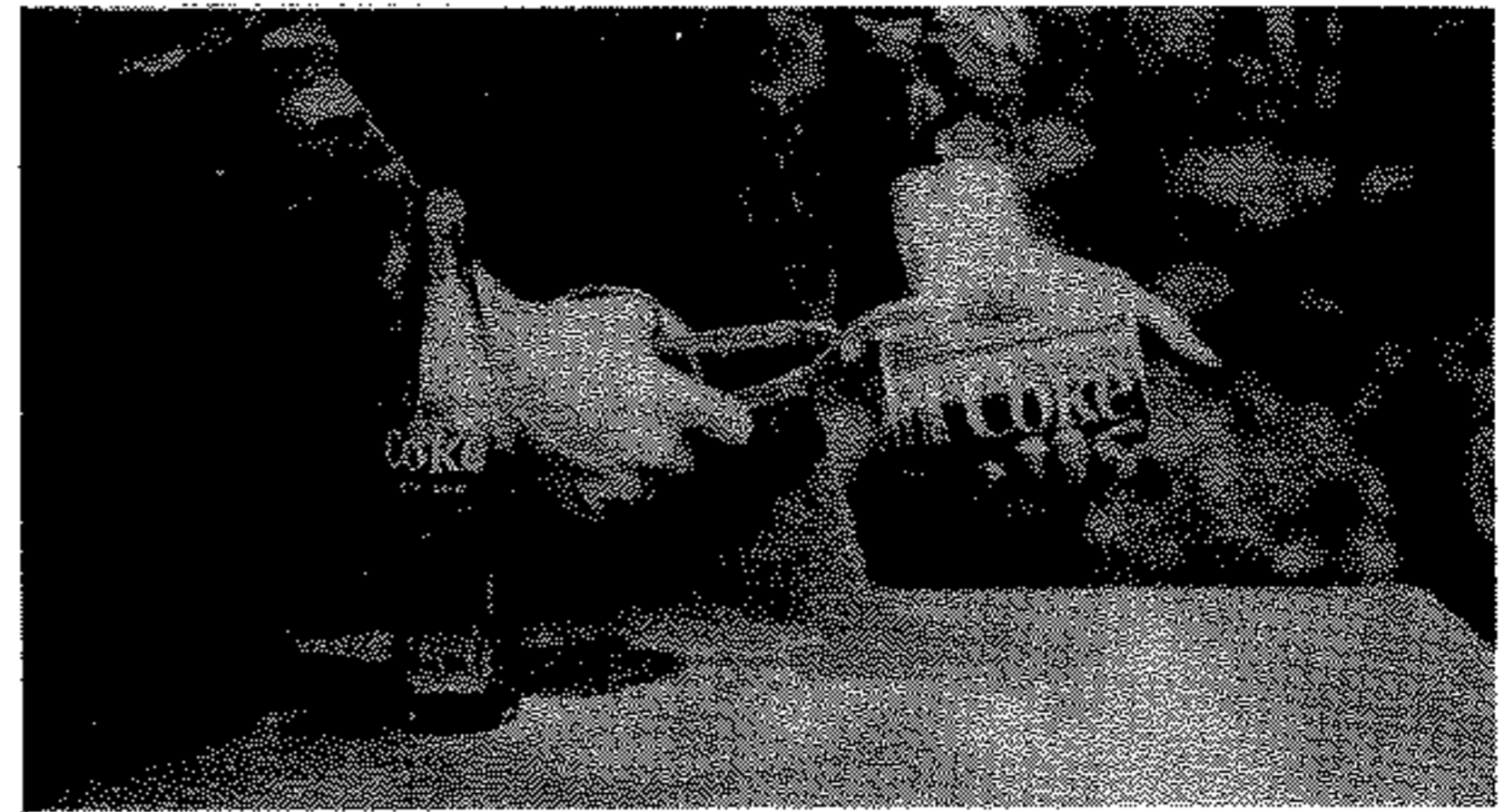

FIGURE 9

The outer container should fit snugly around the widest portion of the Coke bottle. Here a Special Forces instructor is removing the bottom of the Coke can so that it will fit over the bottle.

The Coke* bottle is unique in its application as a shaped charge liner since it has a sealed, "built in" standoff distance and can be used underwater to attack concrete bridge pilings or similar targets without the water filling the standoff distance and markedly reducing penetration.

The first step in preparing the Coke bottle charge is to find a suitable outer confinement container such as a tin can or steel pipe (make sure it fits tightly around the widest part of the bottle as in Figure 9). Secure it to the bottle with tape. Warmed C-4 is then packed into the bottle and carefully tamped to remove all air pockets around the cone base and sides (Figure 10). The amount of explosive used is governed by the height of the cone measured from the base of the cone to the top of the explosive (Figure 1). Due to the high velocity

* The word "Coke" used as a product name is a registered trade mark of the Coca-Cola Company.

IMPROVISED SHAPED CHARGES

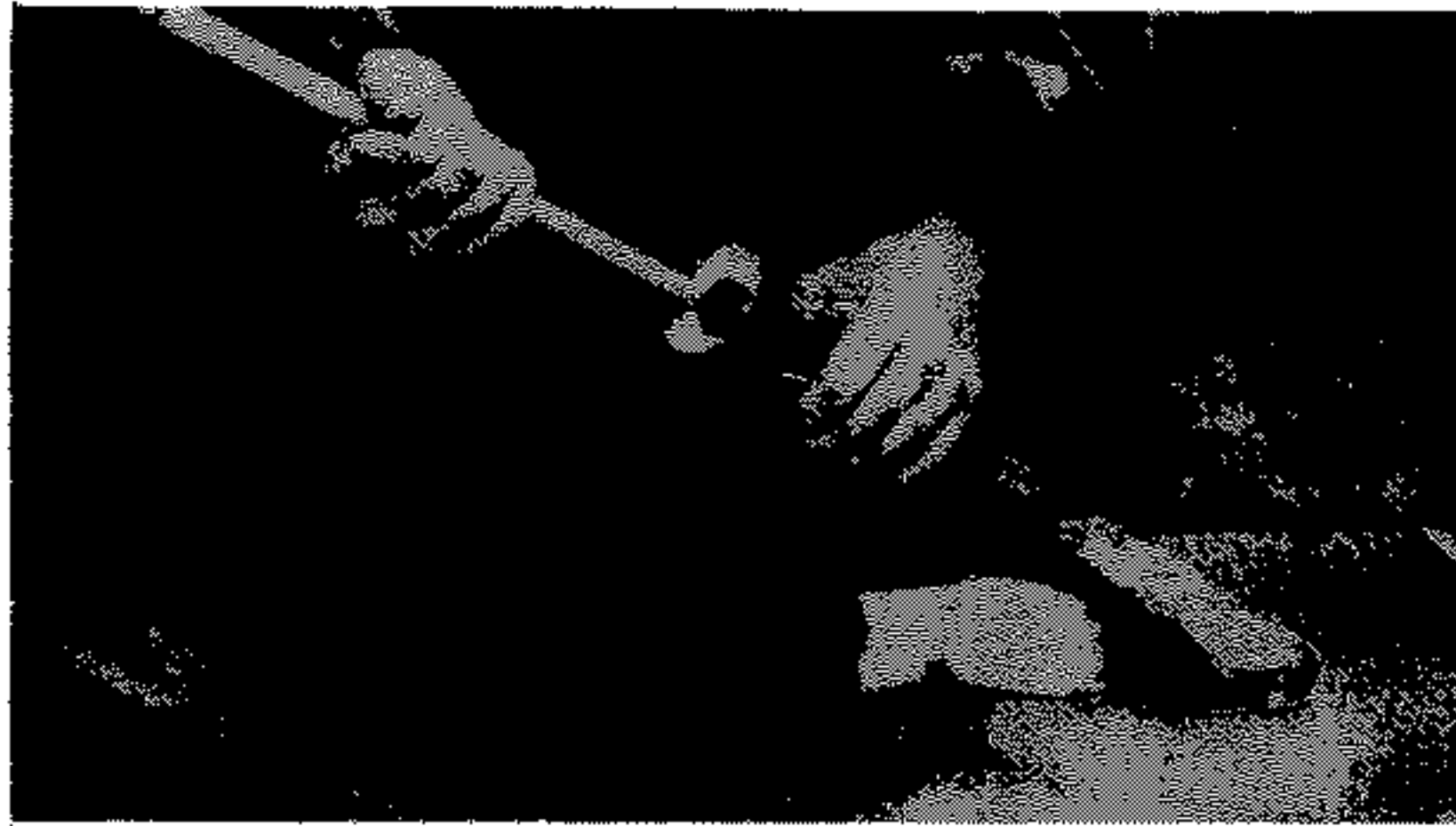

FIGURE 10

After the can is secured over the bottle with tape, warm C-4 plastic explosive is tamped into it.

of the C-4 plastic explosive used for these tests, 2X cone height was all that was needed to achieve maximum penetration. When using explosives with velocities of detonation below 6,000 MPS, 3X cone height should be used.

To conserve explosives, the top of the charge should be dome shaped as in Figure 11. However, if the prepared charge is to be kept for more than a day before detonation, or if homemade solid or liquid explosive is used, a flat-topped charge will do. The point of detonation should be the exact top center and the base of the Coke bottle should be flush against the target (Figure 12). If the target is not flat and horizontal, fasten the bottle to the target by any convenient means, such as by placing magnets around the base of the bottle or placing tape or string around the target and the top of the bottle.

The effectiveness of the Coke bottle shaped charge against 2" thick steel plate is depicted in Figure 13. Note the entrance hole diameter and the amount of ground disturbance beneath

IMPROVISED SHAPED CHARGES

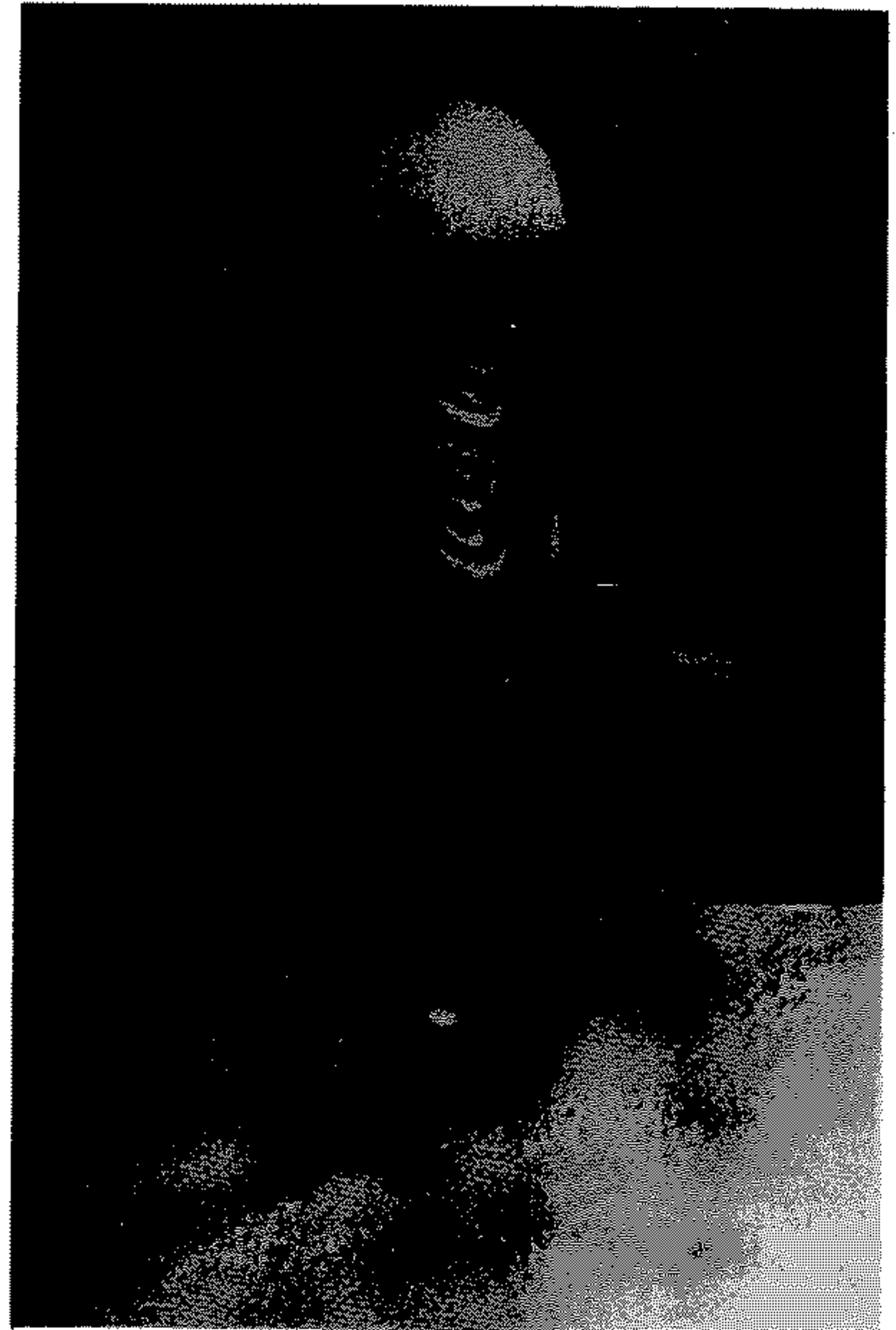

FIGURE 11

The finished Coke bottle improvised shaped charge.

IMPROVISED SHAPED CHARGES

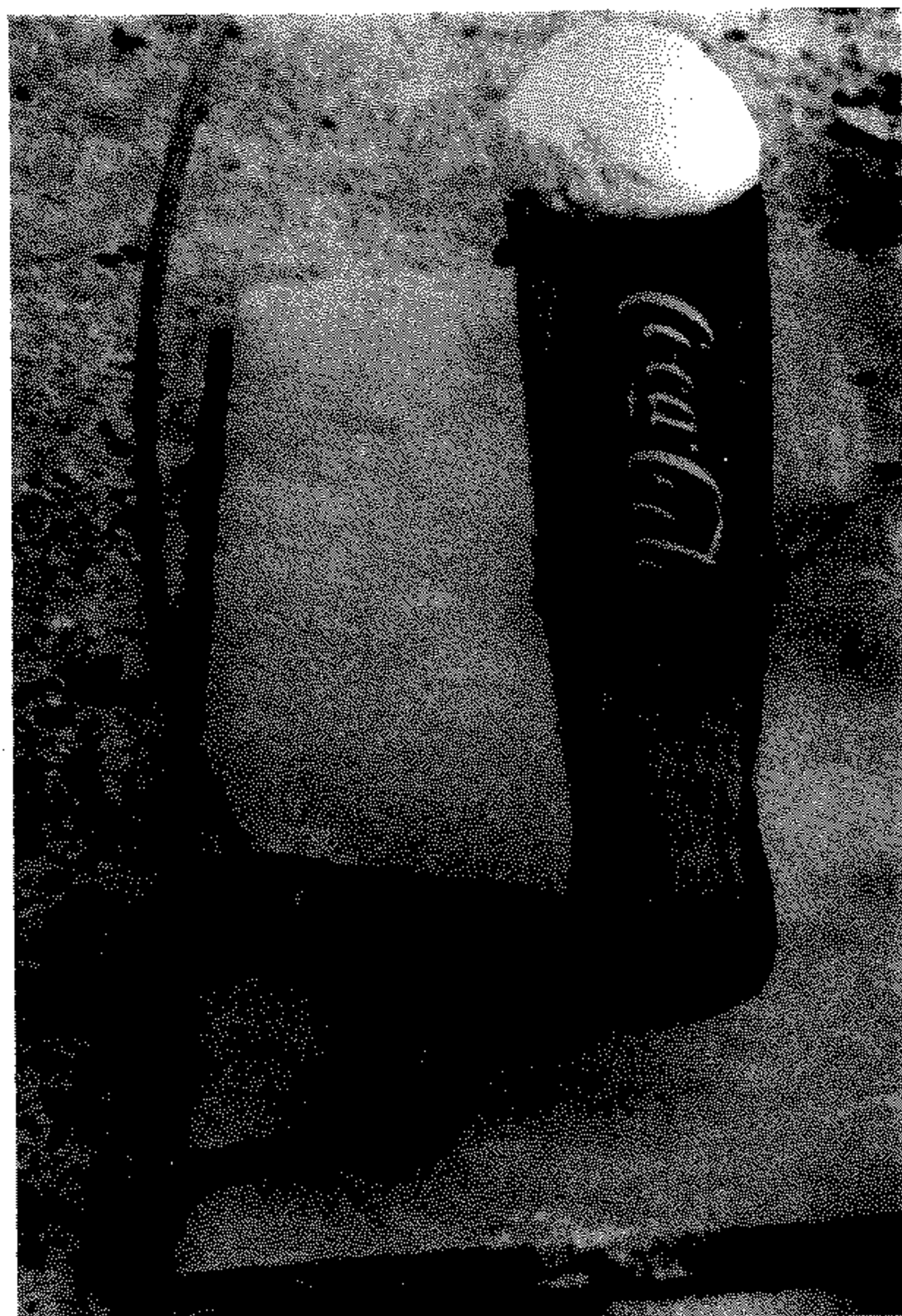

FIGURE 12

Coke bottle charge placed on the target. Note that the bottom of the bottle is flush against the target.

IMPROVISED SHAPED CHARGES



FIGURE 13

Entrance hole of Coke bottle improvised shaped charge in steel plate used for testing.

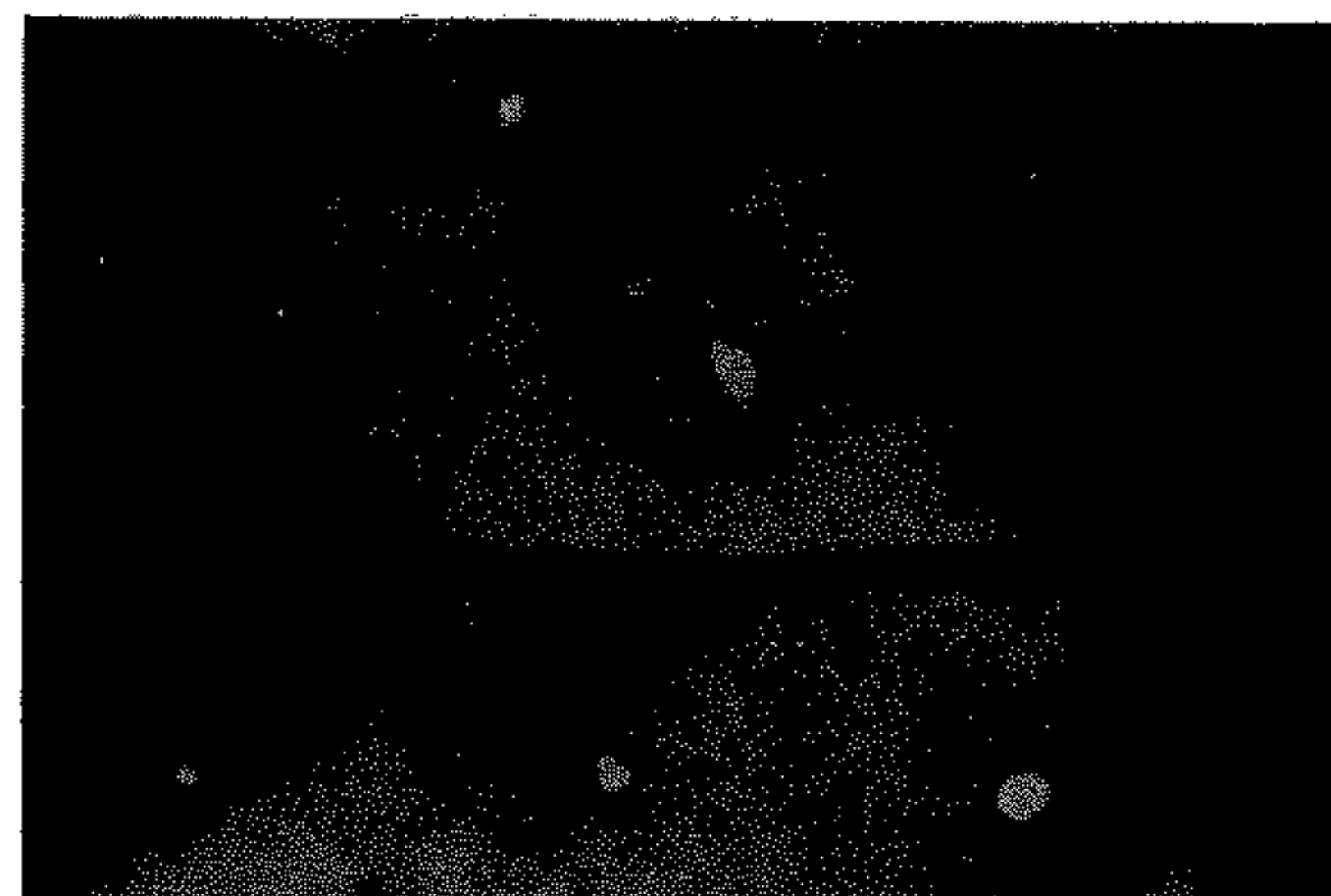

FIGURE 14

Exit hole of Coke bottle improvised shaped charge.

IMPROVISED SHAPED CHARGES

the plate. The exit hole is shown in Figure 14. Since the metal which had been below the charge was pushed into the form of a "rim" around the hole rather than blown free, it would indicate that the Coke bottle shaped charge should not be used on hard steel targets with a thickness greater than 3" if complete penetration is expected.

MARTINI GLASS IMPROVISED SHAPED CHARGES

Because of the uniformity of the cone shape in a martini glass, this charge produced the best results of the three improvised shaped charges tested. The first step in preparing the martini glass shaped charge is to file a notch around the stem at the apex of the cone (Figure 15). Rap the stem sharply against a solid object to break it off from the cone of the glass (Figure 16). Place the glass upside down in any cylindrical

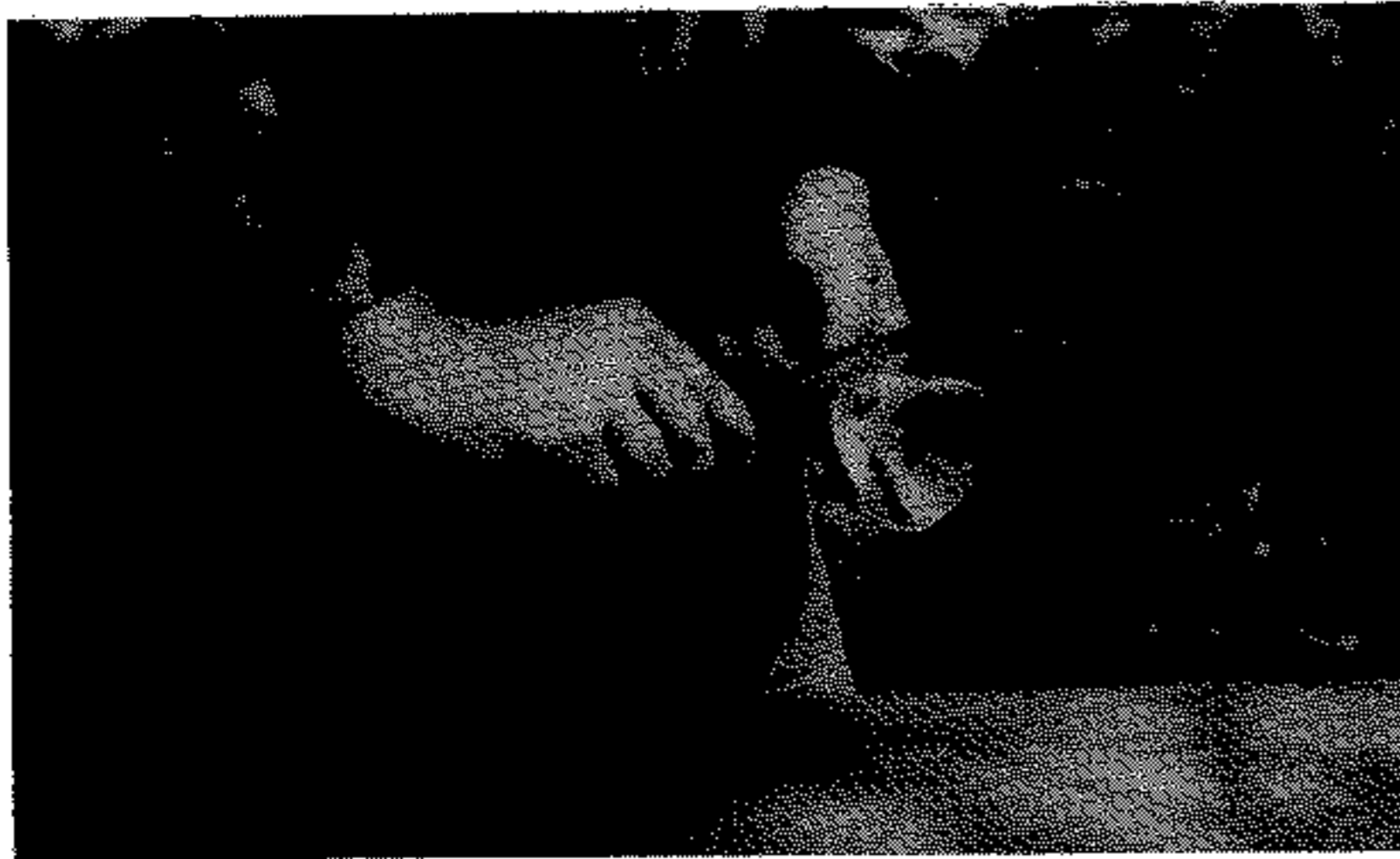

FIGURE 15

The first step in making a martini glass improvised shaped charge is to file around the stem of the glass, then break it off.

IMPROVISED SHAPED CHARGES

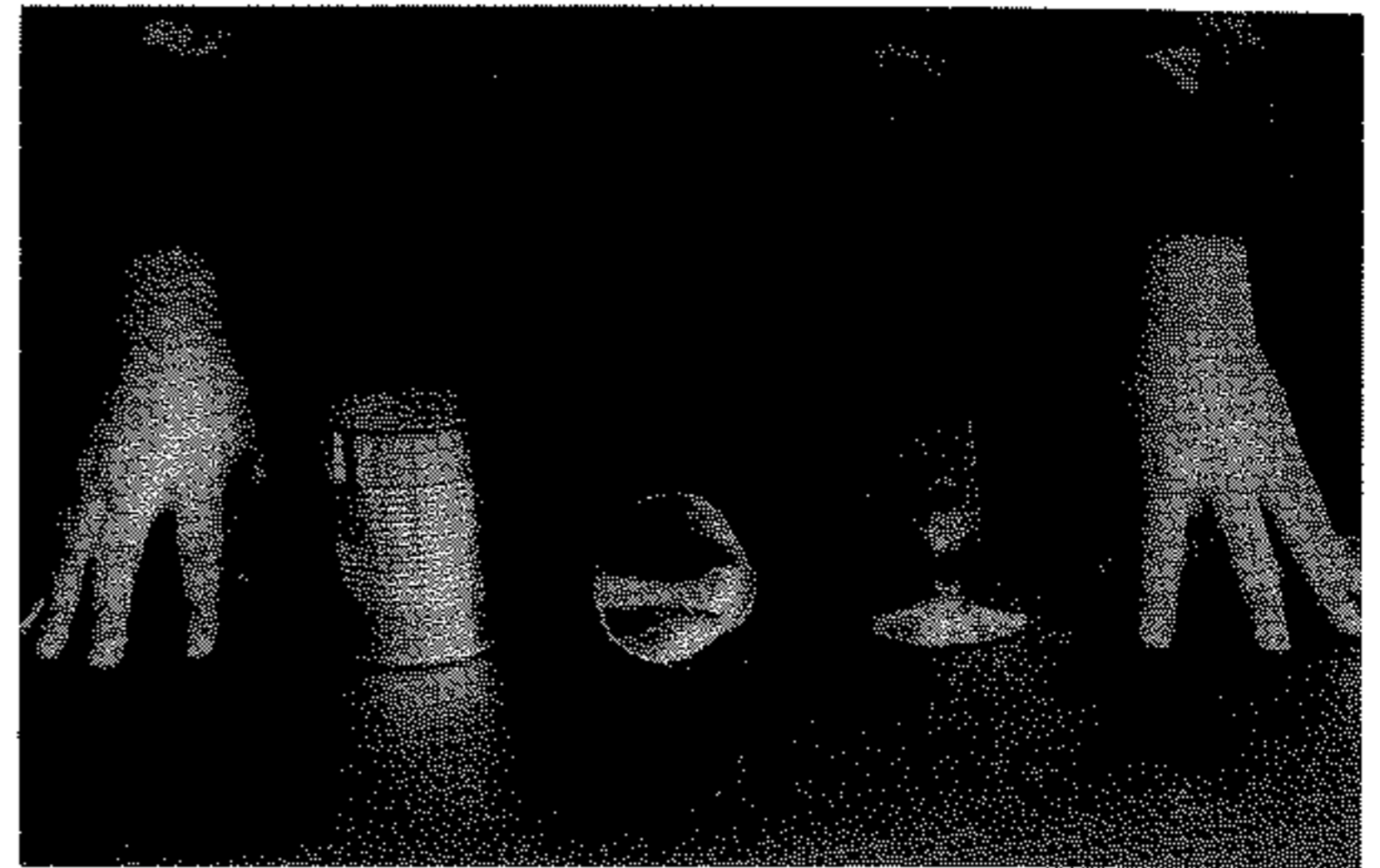

FIGURE 16

The glass is then placed upside down in a container (tin can or steel pipe) which has the same inside diameter as the mouth of the glass.

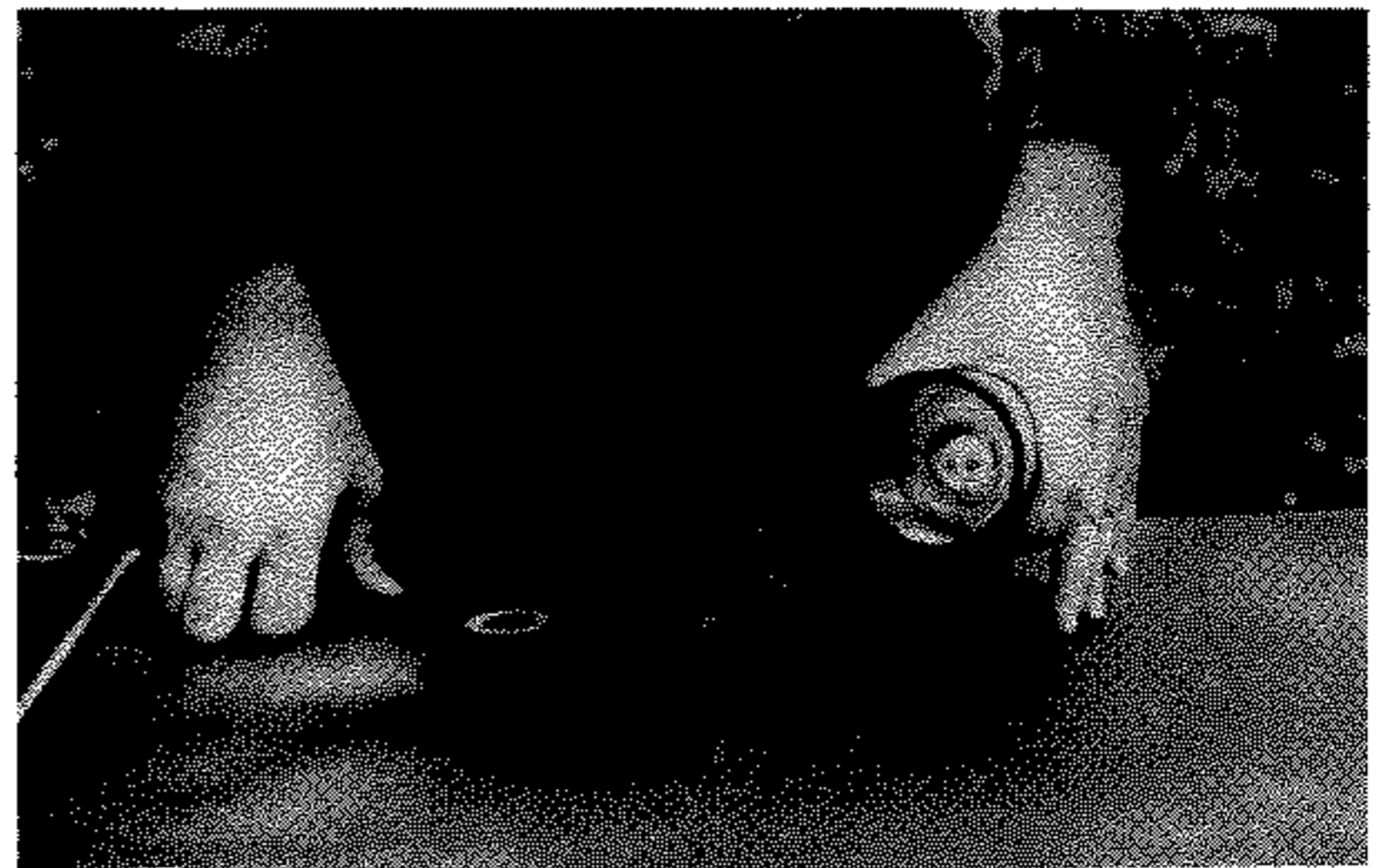

FIGURE 17

The glass should be secured in place with tape.

IMPROVISED SHAPED CHARGES

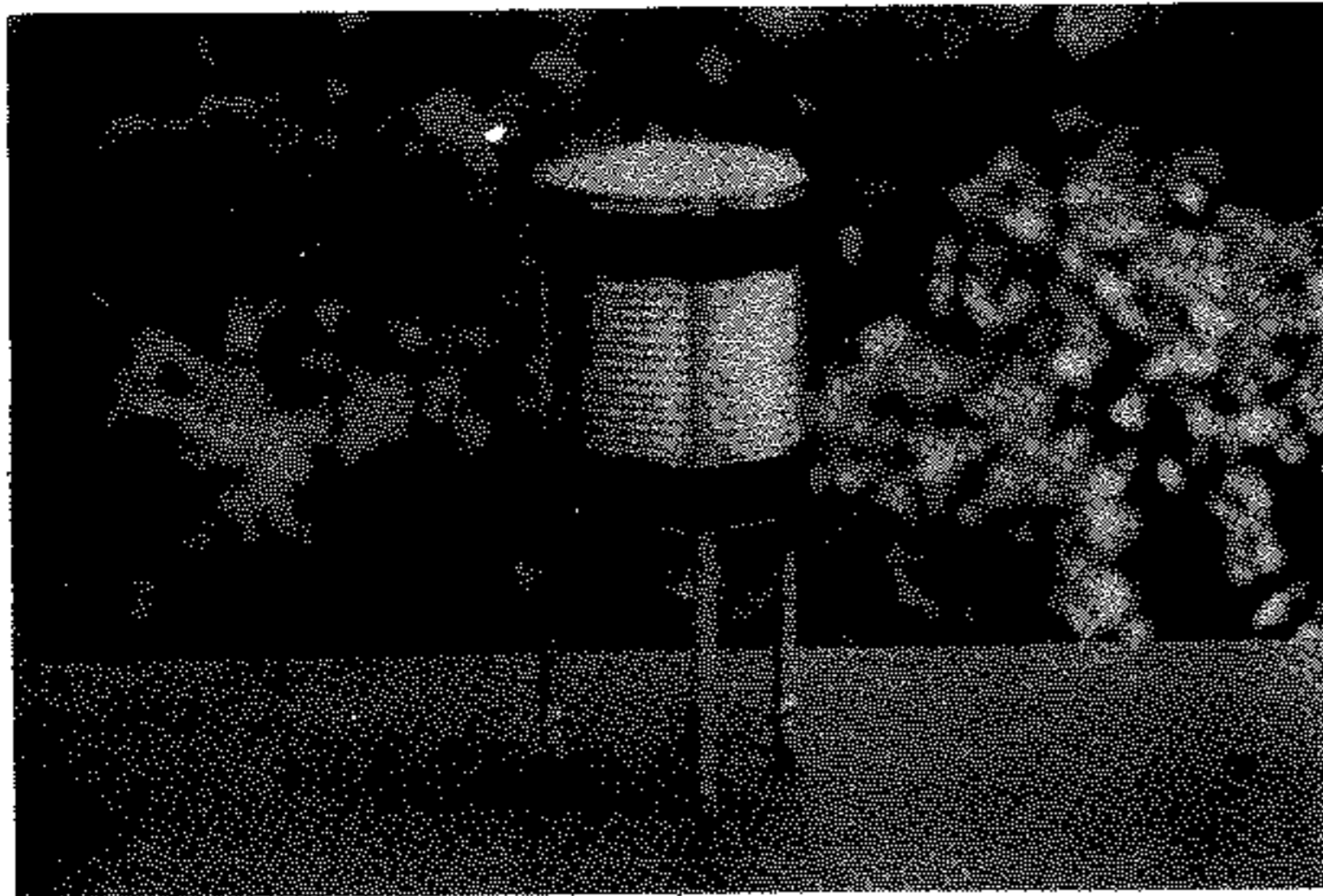

FIGURE 18

The finished martini glass improvised shaped charge. Eraser ends of pencils should be placed on target for traction.

cal container (tin can or steel pipe) fashioned to the diameter of the mouth of the glass, then tape in place as shown in Figure 17.

Next, load the explosive into the container in the same manner as was used for the Coke bottle shaped charge. But unlike the Coke bottle charge, there is no "built in" standoff provided for the martini glass shaped charge. A standoff can be improvised by taping or tying three pencils to the charge to form a tripod. The erasers of the pencils should be placed against the target material to prevent slippage (Figure 18).

The charge should be primed with a blasting cap in the exact rear center as before (Figure 19). The effectiveness of this charge against 2" thick steel plate is shown in Figure 20. Note the increased size of the hole and amount of ground disturbance beneath the plate as compared to the Coke bottle

IMPROVISED SHAPED CHARGES

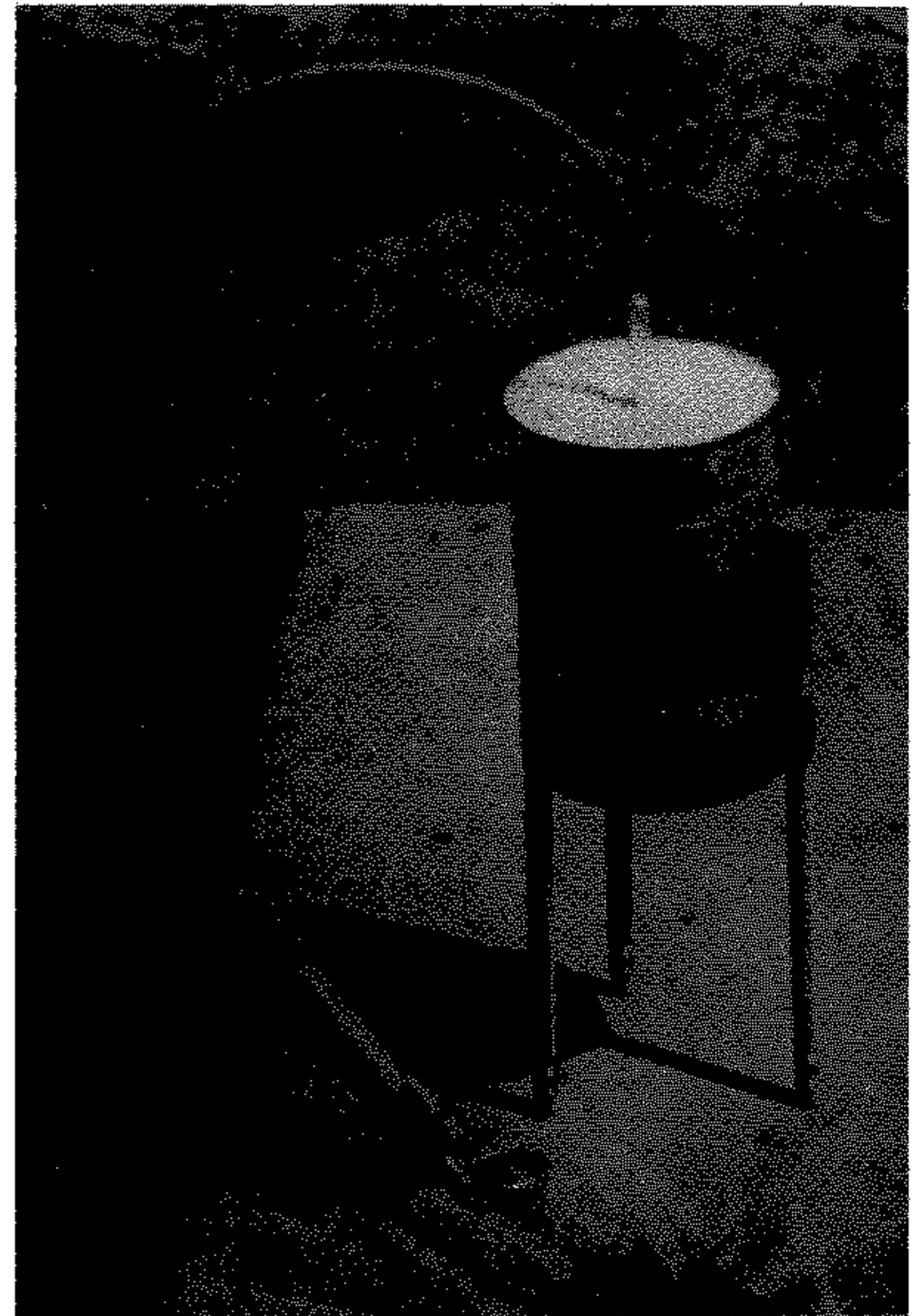

FIGURE 19

As with all charges, the detonating device should be placed in the exact rear center of the explosive.

IMPROVISED SHAPED CHARGES

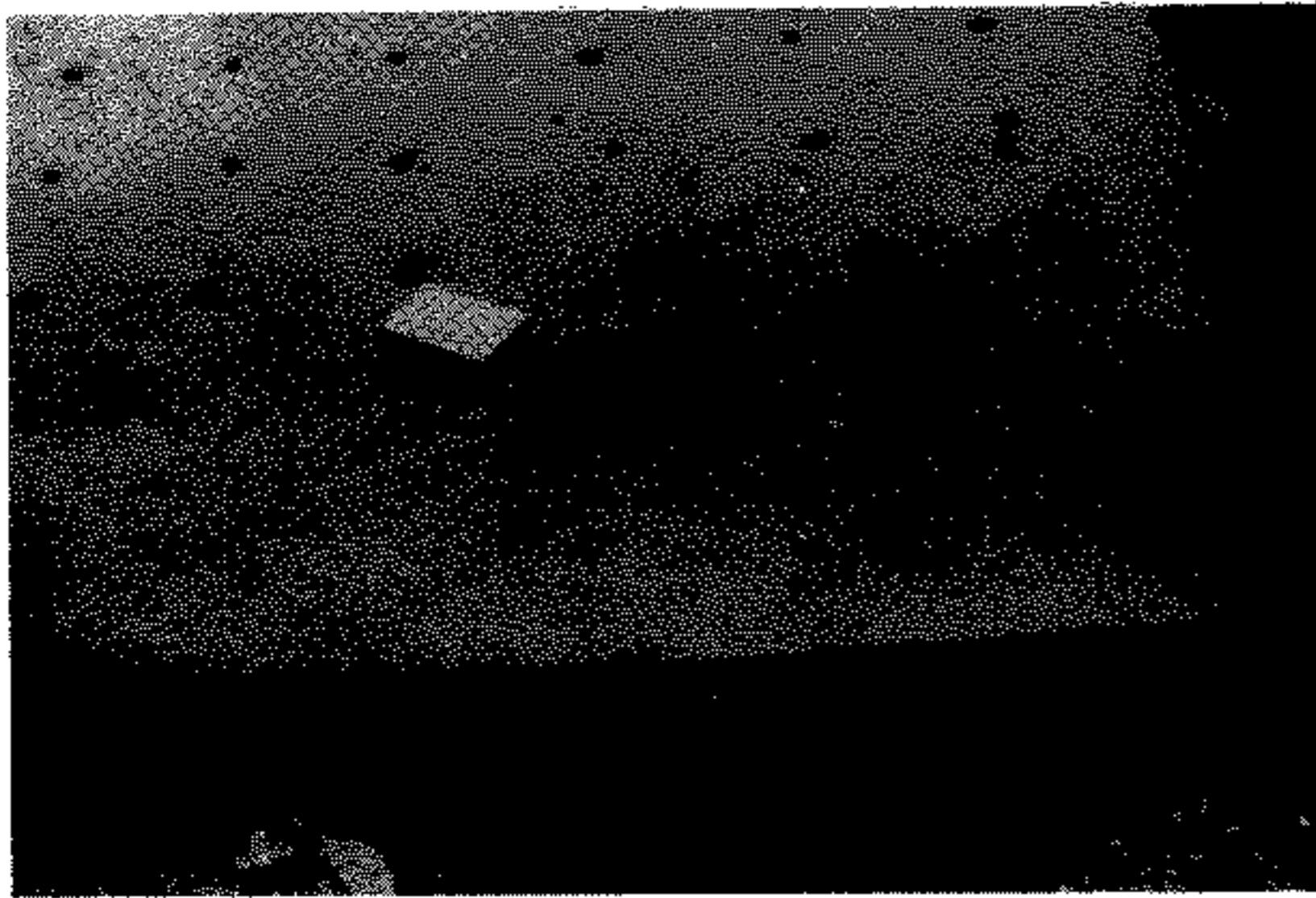

FIGURE 20

Entrance hole of martini glass improvised shaped charge.

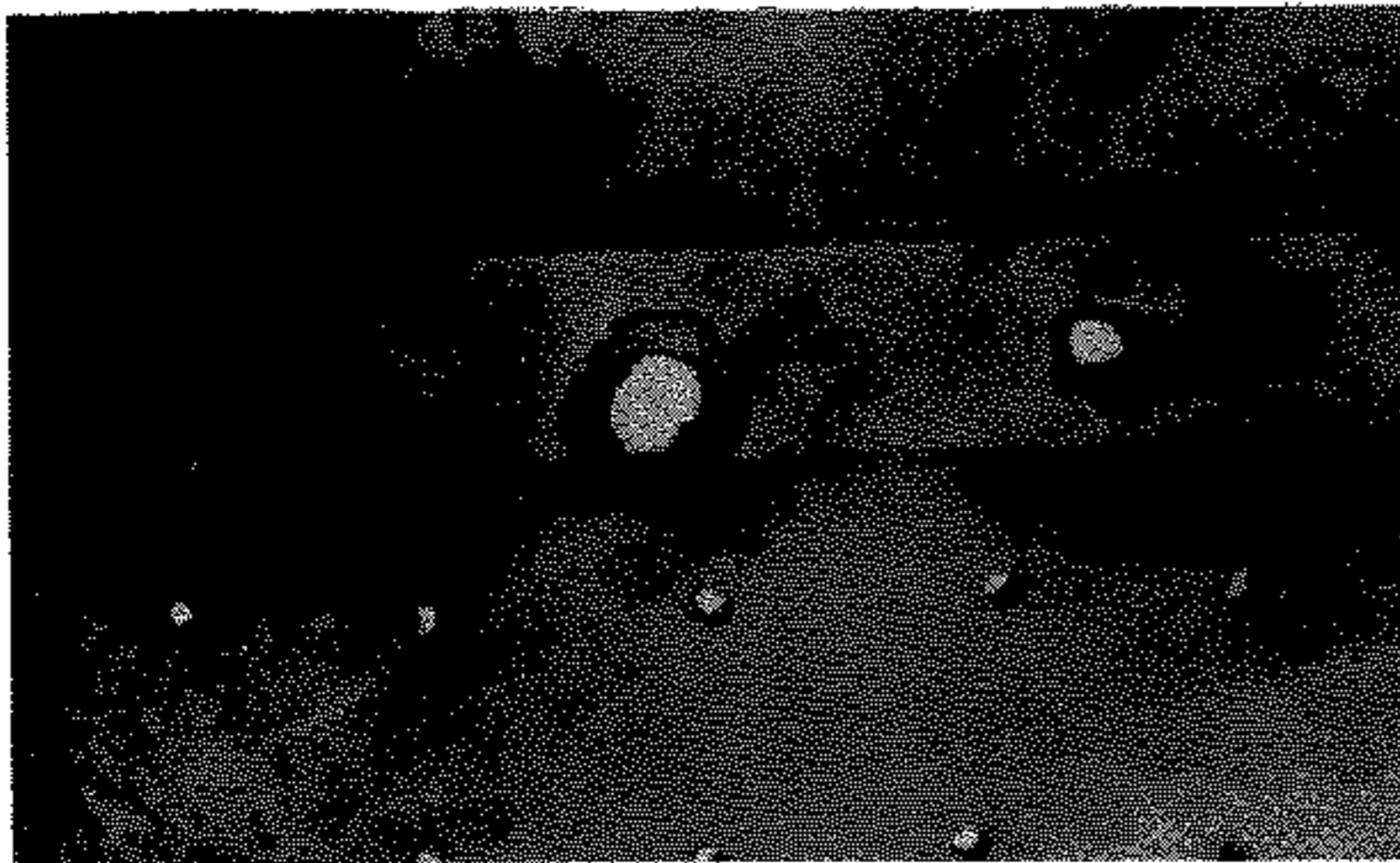

FIGURE 21

Exit hole of martini glass charge is obviously much larger than that made by the Coke bottle charge.

IMPROVISED SHAPED CHARGES

shaped charge. Because of the clean breakage of metal at the exit hole (Figure 21) it is believed that the martini glass shaped charge can be used on steel targets well in excess of 3" in thickness.

WINE BOTTLE IMPROVISED SHAPED CHARGE

Due to the fact that the cone in the bottom of a wine or cognac bottle is more uniform than the cone formed by a Coke bottle, the penetration proved to be slightly superior and can be used on steel targets up to 4" in thickness.

The first step in preparing the wine bottle shaped charge is to separate the bottom half from the top half. This can be accomplished, usually after several attempts, in the following manner: Remove the labels from the bottle, then soak a string or shoe lace in gasoline or kerosene and tie it around



FIGURE 22

To separate the two halves of the wine bottle, heat the cut line by wrapping it with string soaked in gasoline or kerosene, then lighting it.

IMPROVISED SHAPED CHARGES

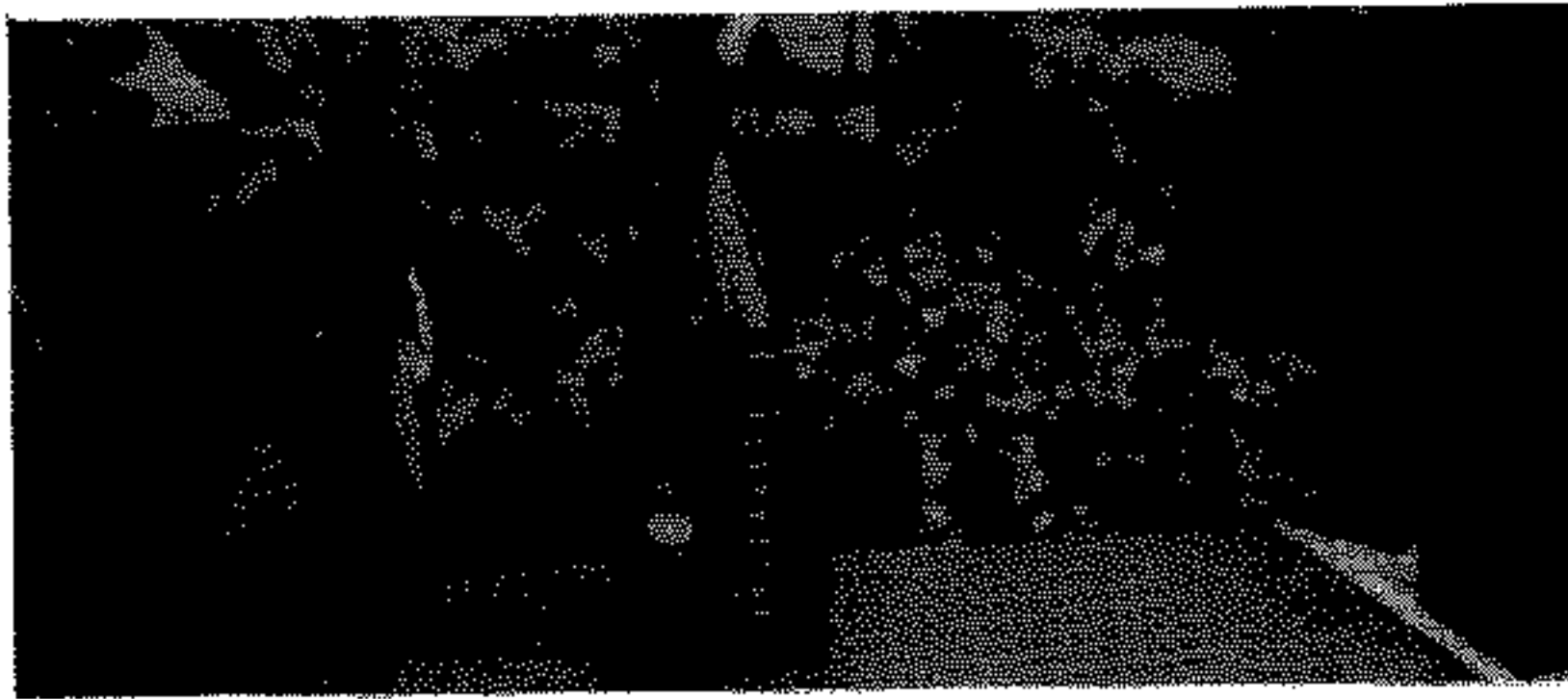

FIGURE 23

Once the string has almost burned away, dunk the bottle into a container of cold water. It should crack and separate easily.

the bottle at the point to be cut. Allow enough room above the apex of the cone to fill with explosive. Grasp the bottle by the neck, light the string, and rotate the bottle on a horizontal plane while the string is burning (Figure 22). When the burning starts to die out plunge the bottle into a bucket or other large container filled with cold water (Figure

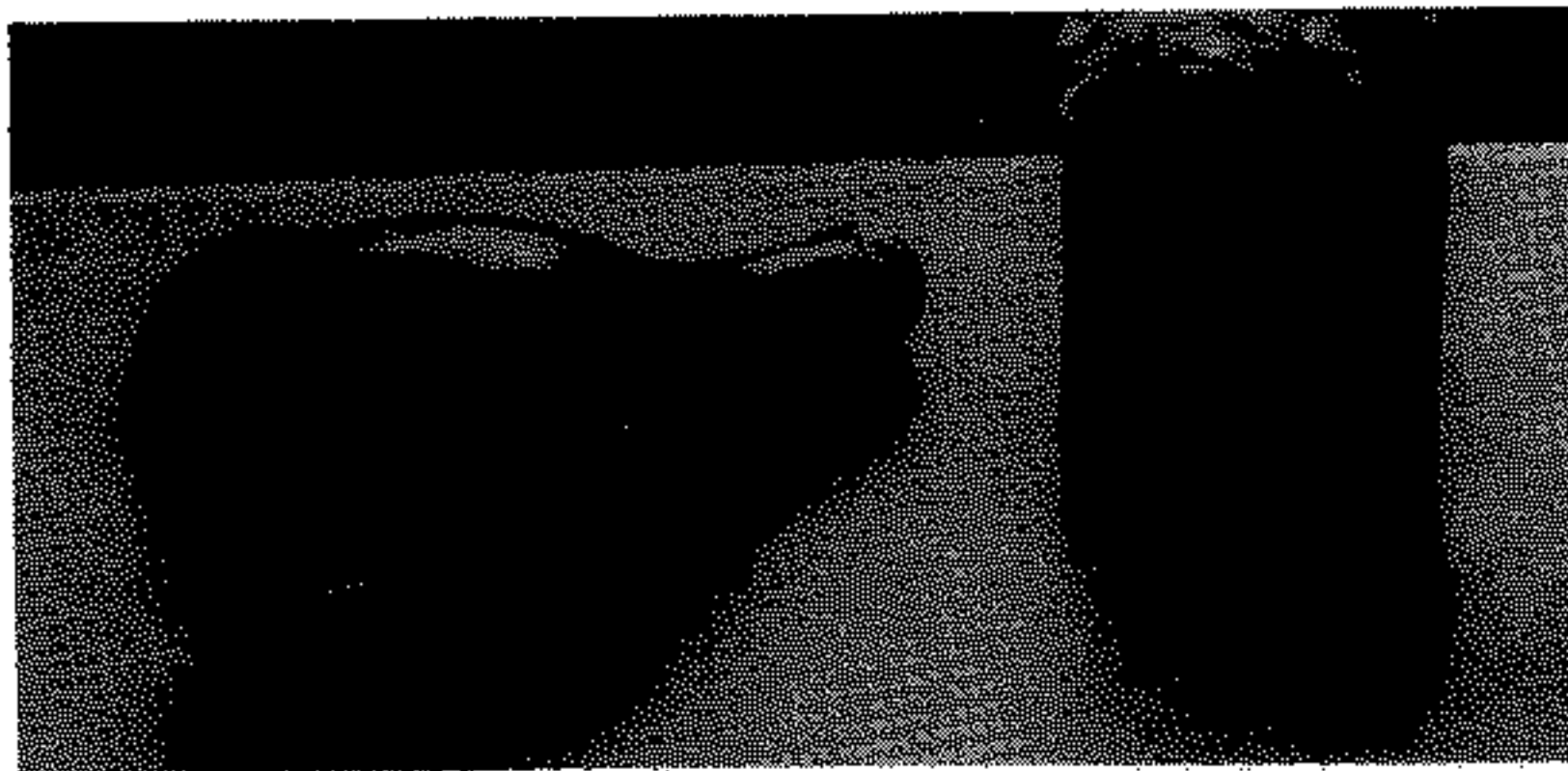

FIGURE 24

Sharp edges where the bottle was separated should be covered with tape or rags to protect the hands while packing with plastic explosive.

IMPROVISED SHAPED CHARGES

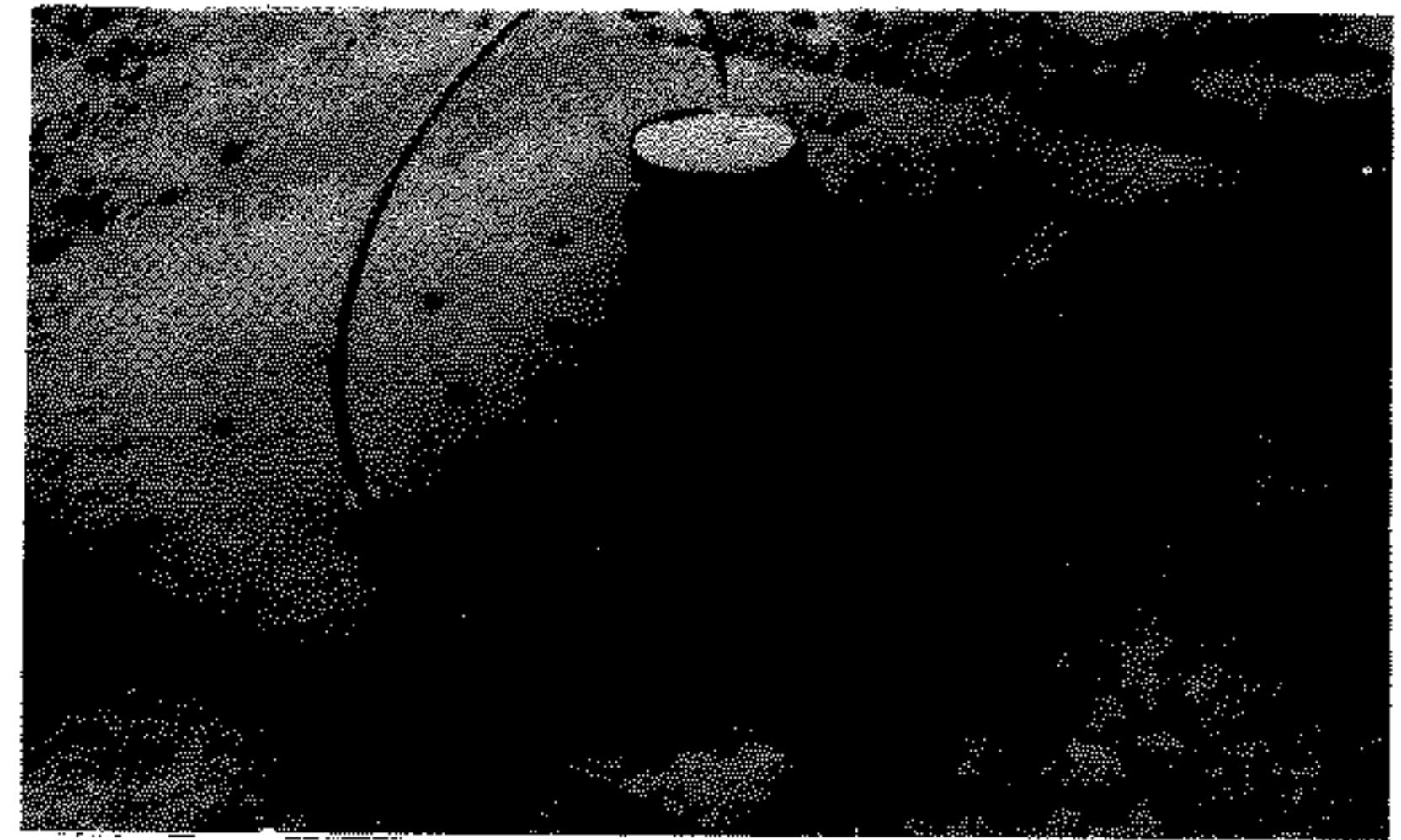

FIGURE 25

The finished wine bottle charge is shown in position on the target.

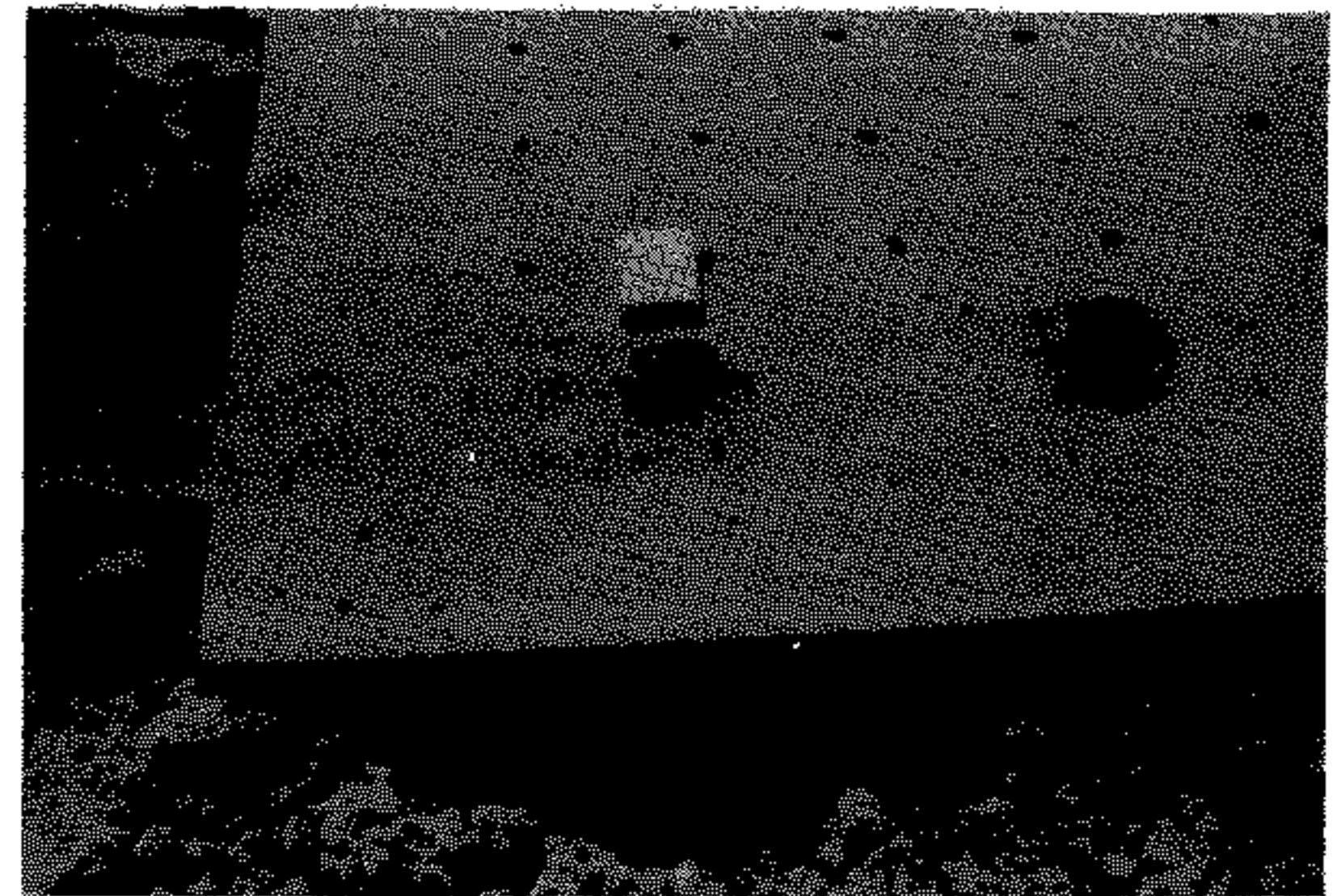

FIGURE 26

Entrance hole of wine bottle improvised shaped charge.

IMPROVISED SHAPED CHARGES

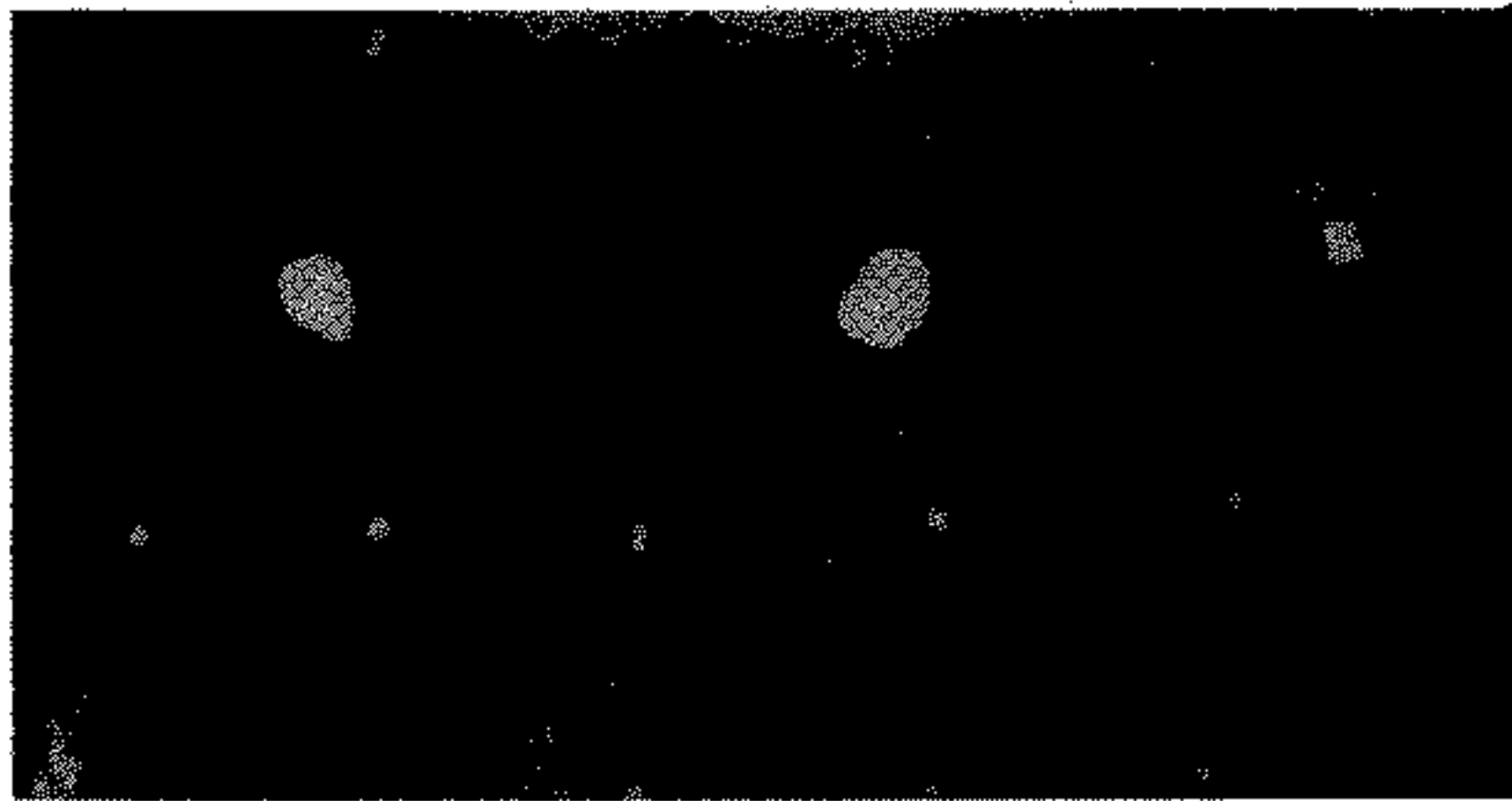

FIGURE 27

Exit hole of wine bottle charge is at left, the rimming effect highly visible.

23). The bottle should crack and separate easily along the line of the string (Figure 24). Cover the sharp edges with tape or rags to protect the hands during loading, then load the explosive in the same manner as was used for the Coke bottle and martini glass shaped charges. Provide the same type of standoff as was used for the martini glass shaped charge.

The charge should be primed with a blasting cap placed in the exact rear center as before (Figure 25). The effectiveness of this charge against 2" thick steel plate is depicted in Figure 26. Note the hole size and ground disturbance as compared to the Coke bottle and martini glass shaped charges. Figure 27 shows the exit hole for the wine bottle shaped charge. Again, note the "rim" around the hole rather than a clean separation, indicating that the wine bottle should not be used on hard steel targets greater than 4" in thickness if complete penetration is to be achieved.